

---

# Owner's Manual

---

## MOTORIZED TROLLEY SMR2Q SERIES

1/8-1Ton Capacity

Code, Lot and Serial Number

### **⚠ WARNING**

This equipment should not be installed, operated or maintained by any person who has not read and understood all the contents of this manual. Failure to read and comply with the contents of this manual can result in serious bodily injury or death, and/or property damage.

**HARRINGTON**  
A KITO GROUP COMPANY

# Table of Contents

Section	Page Number
1.0 Important Information and Warnings.....	4
1.1 Terms and Summary	
1.2 Warning Tag and Labels	
2.0 Technical Information .....	8
2.1 Specifications	
2.2 Dimensions	
3.0 Pre-operational Procedures.....	10
3.1 Assembly and Adjustment	
3.2 Mounting Location	
3.3 Installation of Trolley onto Beam	
3.4 Electrical Connections	
3.5 VFD Setup	
3.6 Pre-operational Checks and Trial Operation	
4.0 Operation.....	28
4.1 Introduction	
4.2 Shall's and Shall Not's for Operation	
4.3 Trolley and Hoist Controls	
5.0 Inspection.....	32
5.1 General	
5.2 Inspection Classification	
5.3 Frequent Inspection	
5.4 Periodic Inspection	
5.5 Occasionally Used Trolleys	
5.6 Inspection Records	
5.7 Inspection Methods and Criteria	

<b>Section</b>	<b>Page Number</b>
6.0 Maintenance & Handling.....	38
6.1 Count/Hour Meter	
6.2 Lubrication	
6.3 Brake	
6.4 Storage	
6.5 Outdoor Installation	
6.6 Operational Environment	
7.0 Troubleshooting.....	41
8.0 Warranty.....	43
9.0 Parts List.....	45

## 1.0 Important Information and Warnings

### 1.1 Terms and Summary

This manual provides important information for personnel involved with the installation, operation and maintenance of this product. Although you may be familiar with this or similar equipment, it is strongly recommended that you read this manual before installing, operating or maintaining the product.

**Danger, Warning, Caution and Notice** - Throughout this manual there are steps and procedures that can present hazardous situations. The following signal words are used to identify the degree or level of hazard seriousness.

**⚠ DANGER** Danger indicates an imminently hazardous situation which, if not avoided, **will** result in **death or serious injury**, and property damage.

**⚠ WARNING** Warning indicates an imminently hazardous situation which, if not avoided, **could** result in **death or serious injury**, and property damage.

**⚠ CAUTION** Caution indicates a potentially hazardous situation which, if not avoided, **may** result **minor or moderate injury** or property damage.

**NOTICE** Notice is used to notify people of installation, operation, or maintenance information which is important but not directly hazard-related.

### **⚠ CAUTION**

These general instructions deal with the normal installation, operation, and maintenance situations encountered with the equipment described herein. The instructions should not be interpreted to anticipate every possible contingency or to anticipate the final system, crane, or configuration that uses this equipment. For systems using the equipment covered by this manual, the supplier and owner of the system are responsible for the system's compliance with all applicable industry standards, and with all applicable federal, state and local regulations/codes.

This manual includes instructions and parts information for a variety of trolley and hoist types. Therefore, all instructions and parts information may not apply to any one type or size of specific trolley or hoist. Disregard those portions of the instructions that do not apply.

Record your trolley's Code, Lot and Serial Number on the front cover of this manual for identification and future reference to avoid referring to the wrong manual for information or instructions on installation, operation, inspection, maintenance, or parts.

Use only Harrington authorized replacement parts in the service and maintenance of this trolley.

## **WARNING**

Equipment described herein is not designed for and **MUST NOT** be used for lifting, supporting, or transporting people, or for lifting or supporting loads over people.

Equipment described herein should not be used in conjunction with other equipment unless necessary and/or required safety devices applicable to the system, crane, or application are installed by the system designer, system manufacturer, crane manufacturer, installer, or user.

Modifications to upgrade, rerate, or otherwise alter this equipment shall be authorized only by the original equipment manufacturer.

Equipment described herein may be used in the design and manufacture of cranes or monorails. Additional equipment or devices may be required for the crane and monorail to comply with applicable crane design and safety standards. The crane designer, crane manufacturer, or user is responsible to furnish these additional items for compliance. Refer to ANSI/ASME B30.17, "Safety Standard for Top-Running Single Girder Cranes"; ANSI/ASME B30.2 "Safety Standard for Top-Running Double-Girder Cranes"; and ANSI/ASME B30.11 "Safety Standard for Underhung Cranes and Monorails".

If a below-the-hook lifting device or sling is used with a hoist, refer to ANSI/ASME B30.9, "Safety Standard for Slings" or ANSI/ASME B30.20, "Safety Standard for Below-the-Hook Lifting Devices".

Hoists, trolleys and cranes, used to handle hot molten material may require additional equipment or devices. Refer to ANSI Z241.2, "Safety Requirements for Melting and Pouring of Metals in the Metal Casting Industry".

Electrical equipment described herein is designed and built in compliance with Harrington's interpretation of ANSI/NFPA 70, "National Electrical Code". The system designer, system manufacturer, crane designer, crane manufacturer, installer, or user is responsible to assure that the installation and associated wiring of these electrical components is in compliance with ANSI/NFPA 70, and all applicable Federal, State and Local Codes.

Failure to read and comply with any one of the limitations noted herein can result in serious bodily injury or death, and/or property damage.



## **DANGER**

**HAZARDOUS VOLTAGES ARE PRESENT IN THE CONTROL BOX, OTHER ELECTRICAL COMPONENTS, AND CONNECTIONS BETWEEN THESE COMPONENTS.**

Before performing ANY mechanical or electrical maintenance on the equipment, de-energize (disconnect) the main switch supplying power to the equipment; and lock and tag the main switch in the de-energized position. Refer to ANSI Z244.1, "Personnel Protection – Lockout/Tagout of Energy Sources".

Only trained and competent personnel should inspect and repair this equipment.

## **NOTICE**

It is the responsibility of the owner/user to install, inspect, test, maintain, and operate a trolley or hoist in accordance with ANSI/ASME B30.16, "Safety Standard for Overhead Hoists", OSHA Regulations and ANSI/NFPA 70, "National Electric Code". If the trolley is installed as part of a total lifting system, such as an overhead crane or monorail, it is also the responsibility of the owner/user to comply with the applicable ANSI/ASME B30 volume that addresses that type of equipment.

It is the responsibility of the owner/user to have all personnel that will install, inspect, test, maintain, and operate a hoist read the contents of this manual and applicable portions of ANSI/ASME B30.16, "Safety Standard for Overhead Hoists", OSHA Regulations and ANSI/NFPA 70, "National Electric Code". If the trolley is installed as part of a total lifting system, such as an overhead crane, the applicable ANSI/ASME B30 volume that addresses that type of equipment must also be read by all personnel.

If the trolley owner/user requires additional information, or if any information in the manual is not clear, contact Harrington or the distributor of the trolley. Do not install, inspect, test, maintain, or operate this trolley unless this information is fully understood.

A regular schedule of inspection of the trolley in accordance with the requirements of ANSI/ASME B30.16 should be established and records maintained.

## 1.2 Warning Tag and Labels

The warning tag illustrated below in **Figure 1-1** is supplied with each trolley shipped from the factory. If the tag is not attached to the pendant cord for your hoist/trolley, order a tag from your dealer and install it. Read and obey all warnings attached to this trolley. Tag is not shown actual size.



**Figure 1-1** Warning Tag Attached to Trolley Controls

## 2.0 Technical Information

### 2.1 Specifications

**Note:** This Owner's Manual is to be used with the Single Phase Model SEQ hoist's Owner's Manual.

2.1.1 Product Code for SMRQ Single Phase Motorized Trolley Alone:

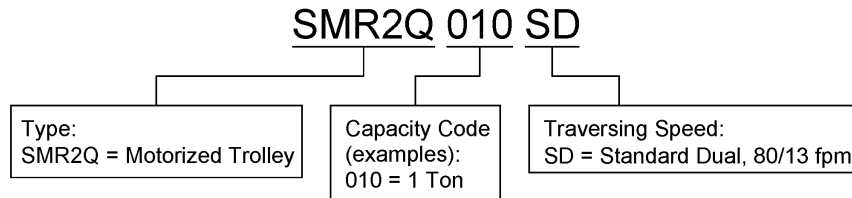

2.1.2 Product Code for SMRQ Single Phase Motorized Trolley with SEQ Series Single Phase Electric Hoist:

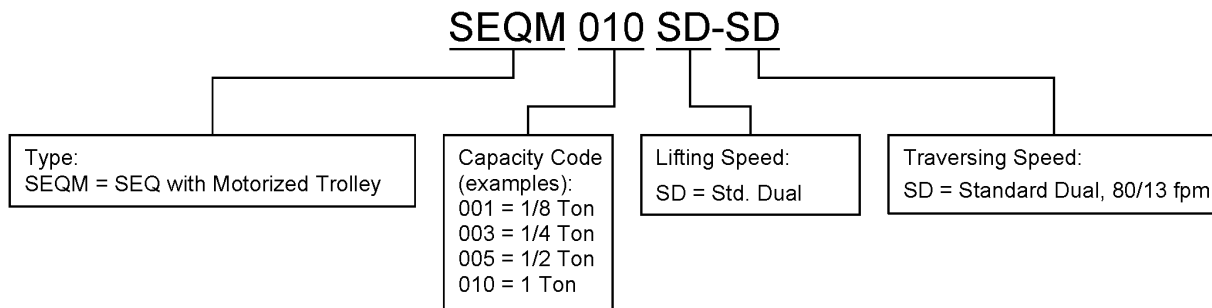

Capacity (Ton)	Product Code	Standard Beam Flange Range (in)	Optional Beam Flange Range (in)	Min. Allowable Radius for Curve (in)	Motor			Approx. Net Weight (lbs)
					Output (Hp)	Current Draw (amps)		
						@115V-60Hz	@220-230V-50/60Hz	
1/8 - 1	SMR2Q010SD	2.28 to 6.02	6.03 to 12.00	31.5*	0.54	4.5	2.1	75

\* Flange widths smaller than 4 inches will have a minimum radius of 137.8 inches

2.1.3 Operating Conditions and Environment

Temperature Range: -4° to +104°F (-20° to +40°C)

Humidity: 85% or less (no condensation)

Noise Level: 85 dB or less (A scale: measured 1 meter away from the electric chain hoist)

Enclosure Rating: Trolley Meets IP55, Pendant Meets IP65

Supply Voltage: 115V-1-60Hz, 220-230V-1-50/60Hz

Intermittent Duty Rating: 27/13% ED with 78/162 starts per hour



## 2.2 Dimensions

Table 2-2 Trolley Dimensions												
For SEQM001 to SEQM010												
	Capacity	b'	b	d	e	e'	i	j	k	m	n	r
1/8-1/2t	15.6	12.4	8.7	20.3	7.1	3.7	1.1	5.1	8.1	4.3	2.0	1.2
1t							0.9					

## 3.0 Pre-operational Procedures

### 3.1 Assembly and Adjustment

3.1.1 The SMR2Q trolley is designed to be combined with the SEQ hoist and it should not be combined with any other hoist model. Follow and complete all pre-operational procedures provided with the SEQ Owner's Manual in conjunction with all information provided in this section for mounting and electrical connections.

3.1.2 **⚠ WARNING** Never attempt to hook mount a hoist directly to the Suspension Shaft on trolleys. These trolleys are designed to be used with a suspender only and do not have the vertical clearance required for a hook to fit between the Suspension Shaft and trolley beam.

3.1.3 Preparing SEQ hoists for use with SMR2Q trolley.

The standard suspension configuration, with a motorized trolley, uses the Suspension Bar which orients the hoist perpendicular to the trolley beam. If the hoist is not equipped with the Suspension Bar, remove the Top Hook Assembly from the hoist and install the Suspension Bar as follows in step 1 through 4. Optional hook mount to Suspender H orients the hoist parallel to the trolley beam (see Figure 3-2).

- 1) Refer to Figure 3-1.
- 2) Remove the Screws. Remove Top Pins.
- 3) Remove the Top Hook Assembly and replace it with the Suspension Bar.
- 4) Reinstall the Top Pins and Screws

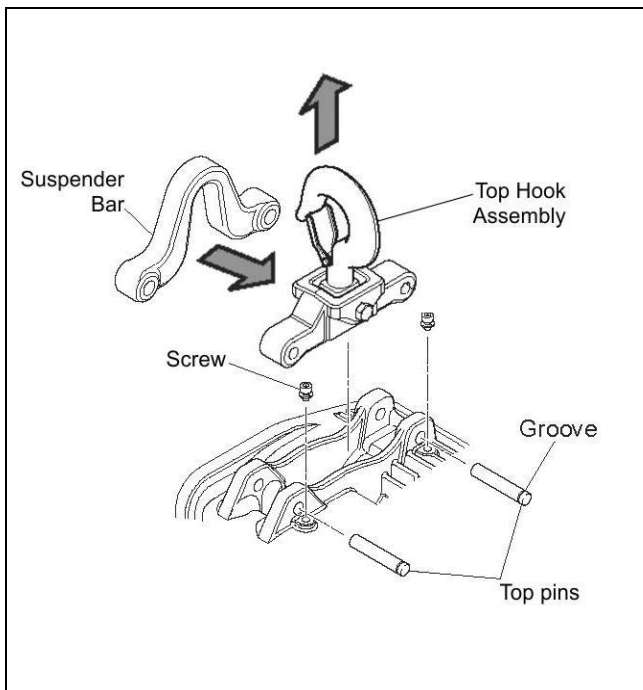

Figure 3-1 Installing Suspension Bar on SEQ Hoists

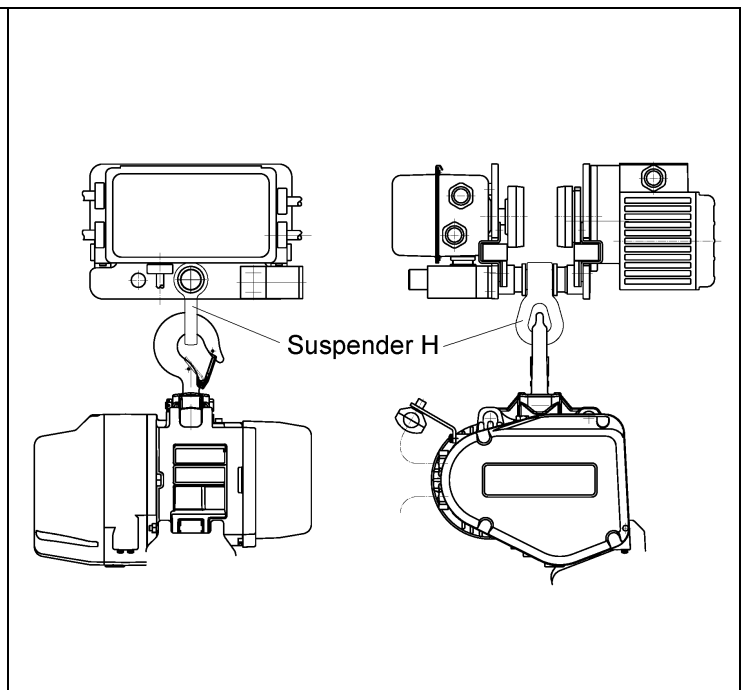
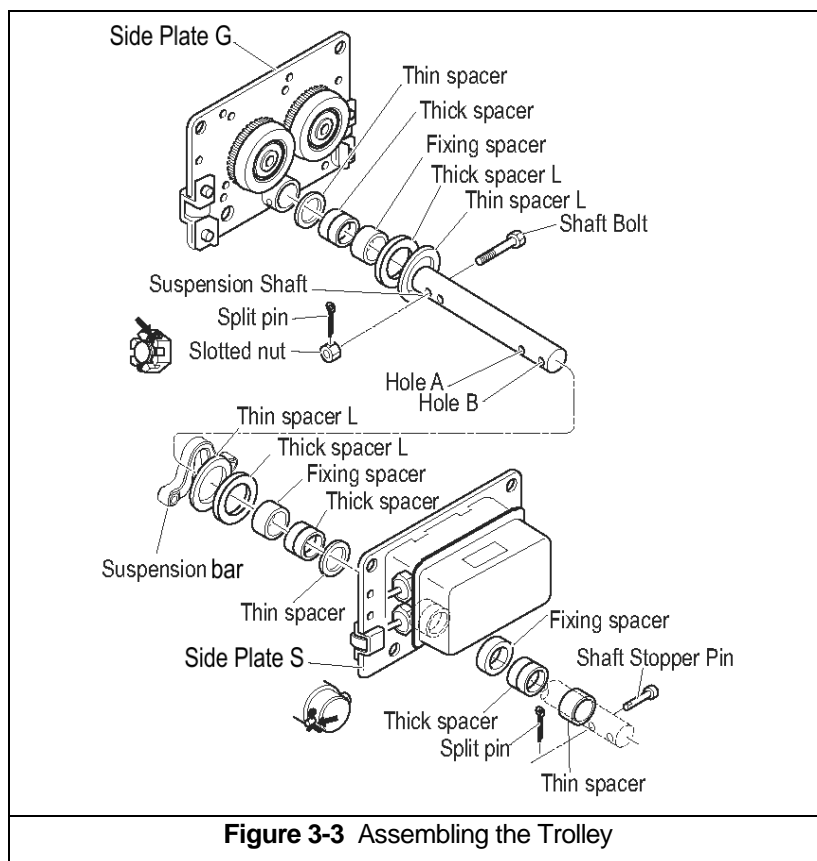
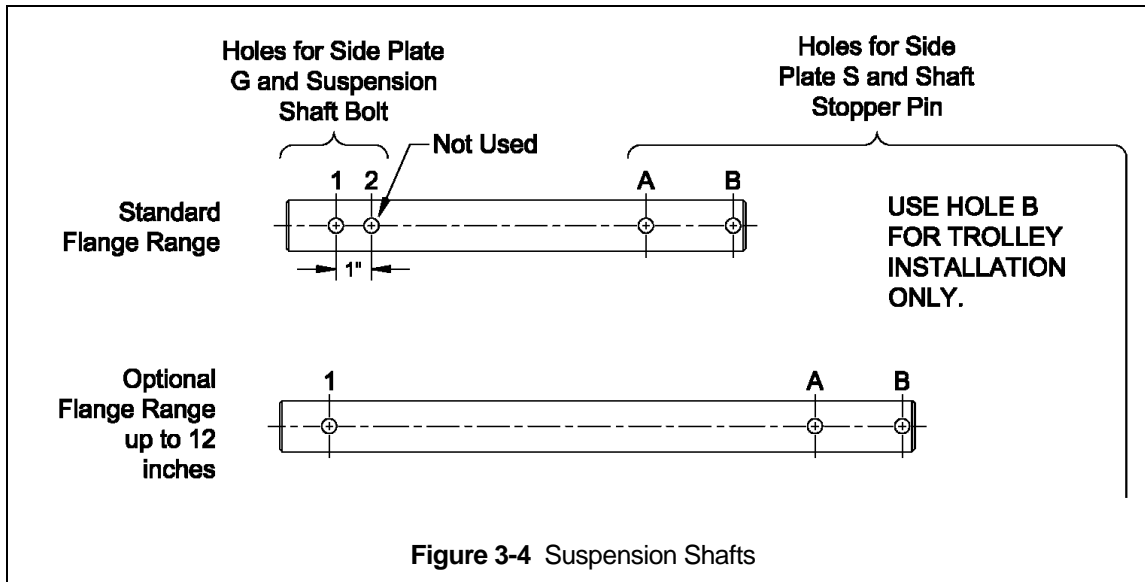

Figure 3-2 Optional Suspender H for parallel mount

### 3.1.4 Trolley Assembly

- 1) Refer to **Figure 3-3**.
- 2) Remove the Shaft Stopper Pin, Side Plate S, and Spacers from the Suspension Shaft. For beam flanges that are wider than the standard range, different suspension shaft and/or spacer arrangements are provided. Refer to **Table 3-1**.
- 3) Insert the Suspension Shaft to Side Plate G and attach it with the Suspension Shaft Bolt, Slotted Nut and Split Pin (cotter pin). Refer to **Figure 3-4** and ensure that correct Suspension Shaft holes are used. Securely bend both branches of the Split Pin after insertion.
- 4) Referring to **Figure 3-6**, **Table 3-1** and **Table 3-2** install the inner adjusting Spacers and Suspension Bar on the Suspension Shaft. Use all of the Spacers provided with the trolley. If the beam width is not listed in **Table 3-2**, use the next size smaller and make adjustments in accordance with **Section 3.1.5**.
- 5) Place Side Plate S into the Suspension Shaft.
- 6) Install the outer adjusting Spacers on the Suspension Shaft outside of Side Plate S. Insert the Shaft Stopper Pin into Hole "A" so that Split Pin is to the left when seen from the front side of trolley switch box. Temporarily install the split pin in the Shaft Stopper Pin and bend the split pin slightly to hold it in place. The split pin should be fully bent after checking and attaining the proper beam flange adjustment.
- 7) **⚠ WARNING** Hole B on the suspension shaft is the hole for mounting work (temporary assembly). Do not use the hole for the adjustment of rail width. Failure to comply with this instruction may result in death or serious injury.





3.1.5 Adjusting the trolley width - After assembling trolley per **Section 3.1.4**, check the adjustment as follows:

- 1) Refer to **Figure 3-5** or **3-6**.
- 2) Make sure both side plates are spread fully outward and Measure Dimension "A". Dimension "A" must be  $\frac{1}{8}$  to  $\frac{3}{16}$ " greater than "B".
- 3) If "A" does not fall within the specified range, move spacers from inner to outer or from outer to inner as necessary to obtain the proper "A" dimension, irrespective of the numbers in **Table 3-2**.
- 4) After obtaining the proper adjustment, install the Shaft Stopper Pin in Hole A, insert the Split Pin into the Shaft Stopper Pin, and securely bend both branches of the split pin.

**NOTICE** For smaller flange widths that are not preset at the factory, the motor cable may have excess slack and need to be secured so that it does not interfere with load chain.

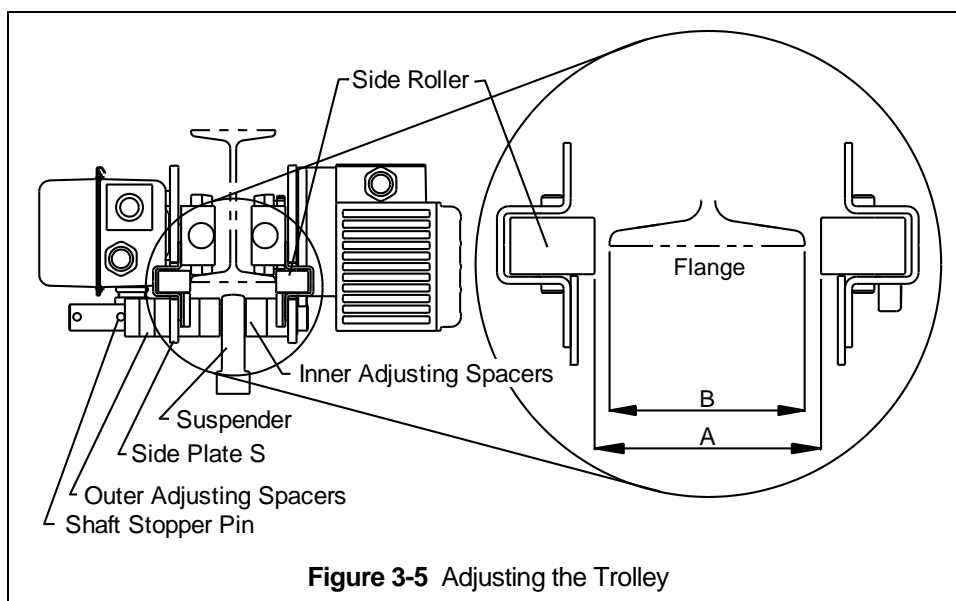

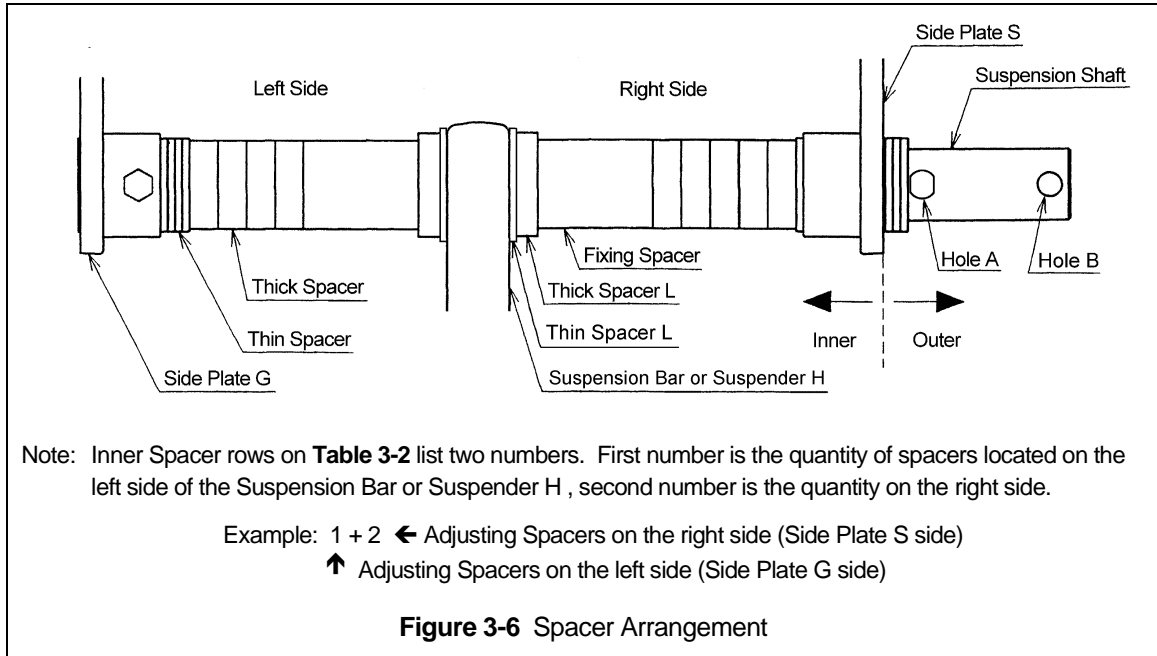

Capacity (Tons)	Flange Range (in)	Total Number of Spacers Supplied					Suspension Shaft Bolt Location
		Thin	Thick	Fixing	Thin L	Thick L	
1/8 to 1/2	2.28 to 6.02	8	5	—	2	2	Hole 1 (See Fig. 3-4)
	6.03 to 12.00	8	9	2	2	2	Hole 1 (See Fig. 3-4)
1	2.28 to 6.02	14	5	—	2	0	Hole 1 (See Fig. 3-4)
	6.03 to 12.00	14	9	2	2	0	Hole 1 (See Fig. 3-4)

**Table 3-2 Number of Adjusting Spacers**

Beam Flange Width (in)		2 5/16	2 1/2	2 7/8	3	3 1/4	3 9/16	3 7/8	3 15/16	4	4 3/16	4 5/16	4 7/16	4 11/16	4 15/16	5	5 3/16	5 5/16	5 3/8	5 5/8	5 7/8	6	6 1/8	6 5/16	6 7/16	6 11/16	6 7/8	7		
Cap. (Ton)	Spacer Type (mm)	58	64	73	75	82	90	98	100	102	106	110	113	119	125	127	131	135	137	143	149	153	155	160	163	170	175	178		
		66	74	76	91		120							150																
1/8, 1/4, and 1/2	Thin	Inner	1+2	2+3	4+4	1+0	1+2	2+3	0+0	1+0	1+0	1+2	2+2	2+3	3+4	4+4	4+1	5+1	2+2	2+2	3+3	4+4	4+1	1+1	2+2	2+3	3+0	4+4	4+1	
		Outer	5	3	0	7	5	3	8	7	7	5	4	3	1	0	3	2	4	4	2	0	3	6	4	3	5	0	3	
	Thick	Inner	0+0	0+0	0+0	0+0	0+0	0+0	1+1	1+1	1+1	1+1	1+1	1+1	1+1	1+1	1+2	1+2	2+2	2+2	2+2	2+2	2+3	3+3	3+3	3+3	3+4	3+3	3+4	
		Outer	5	5	5	5	5	5	3	3	3	3	3	3	3	3	2	2	1	1	1	1	0	3	3	3	2	3	2	
	Fixing	Inner	—	—	—	—	—	—	—	—	—	—	—	—	—	—	—	—	—	—	—	—	—	0	0	0	0	0	0	
		Outer	—	—	—	—	—	—	—	—	—	—	—	—	—	—	—	—	—	—	—	—	—	2	2	2	2	2	2	
	Thick L	Inner	0+0	0+0	0+0	1+1	1+1	1+1	1+1	1+1	1+1	1+1	1+1	1+1	1+1	1+1	1+1	1+1	1+1	1+1	1+1	1+1	1+1	1+1	1+1	1+1	1+1	1+1	1+1	
		Outer	2	2	2	0	0	0	0	0	0	0	0	0	0	0	0	0	0	0	0	0	0	0	0	0	0	0	0	
	Thin L	Inner	1+1	1+1	1+1	1+1	1+1	1+1	1+1	1+1	1+1	1+1	1+1	1+1	1+1	1+1	1+1	1+1	1+1	1+1	1+1	1+1	1+1	1+1	1+1	1+1	1+1	1+1	1+1	
	1	Thin	Inner	0+1	1+2	3+3	4+3	5+4	6+5	3+3	4+3	4+3	5+4	5+5	6+5	7+6	7+7	7+4	8+4	5+5	5+5	6+6	7+7	7+4	4+4	5+5	6+5	6+3	7+7	7+4
			Outer	13	11	8	7	5	3	8	7	7	5	4	3	1	0	3	2	4	4	2	0	3	6	4	3	5	0	3
		Thick	Inner	0+0	0+0	0+0	0+0	0+0	0+0	1+1	1+1	1+1	1+1	1+1	1+1	1+1	1+1	1+2	1+2	2+2	2+2	2+2	2+2	2+3	3+3	3+3	3+3	3+4	3+3	3+4
Outer			5	5	5	5	5	5	3	3	3	3	3	3	3	3	2	2	1	1	1	1	0	3	3	3	2	3	2	
Fixing		Inner	—	—	—	—	—	—	—	—	—	—	—	—	—	—	—	—	—	—	—	—	—	0+0	0+0	0+0	0+0	0+0	0+0	
		Outer	—	—	—	—	—	—	—	—	—	—	—	—	—	—	—	—	—	—	—	—	—	2	2	2	2	2	2	
Thin L		Inner	1+1	1+1	1+1	1+1	1+1	1+1	1+1	1+1	1+1	1+1	1+1	1+1	1+1	1+1	1+1	1+1	1+1	1+1	1+1	1+1	1+1	1+1	1+1	1+1	1+1	1+1	1+1	
		Outer	0	0	0	0	0	0	0	0	0	0	0	0	0	0	0	0	0	0	0	0	0	0	0	0	0	0	0	



## 3.2 Mounting Location

3.2.1 **⚠ WARNING** Prior to mounting the trolley (and hoist) ensure that the trolley beam and its supporting structure are adequate to support the trolley, hoist and its loads. If necessary consult a professional that is qualified to evaluate the adequacy of the suspension location and its supporting structure.

3.2.2 **NOTICE** See **Section 6.5** for outdoor installation considerations.

## 3.3 Installation of Trolley onto Beam

3.3.1 Assemble and adjust the trolley before attempting to install the trolley on the beam.

3.3.2 Preferred Method – Sliding the trolley connected with an electric chain hoist onto the traversing beam from the beam end is the most convenient and recommended method. If the trolley can be mounted from the end of the beam then: Remove the trolley end-stop from the beam and set the trolley on the beam from the end. Securely re-install the trolley end stop on the beam.

3.3.3 Optional Method– If the trolley cannot be mounted from the end of the beam, complete the installation as follows:

- 1) Move the Shaft Stopper Pin to Hole B (see **Figure 3-7**).
- 2) Spread the trolley side plates apart.
- 3) Lift the trolley onto the beam so that the geared wheels (motor side of trolley) rest on the beam's flange.
- 4) Hold Side Plate G securely so that it does not come off the beam then push the side plates together so that all four wheels rest on the beam's flange.
- 5) Remove the Shaft Stopper Pin from Hole B and re-install in Hole A (see **Figure 3-4**). Bend the Split Pin securely. Never use trolley with Shaft Stopper Pin in Hole B. Hole B is ONLY used when installing the trolley on the beam.

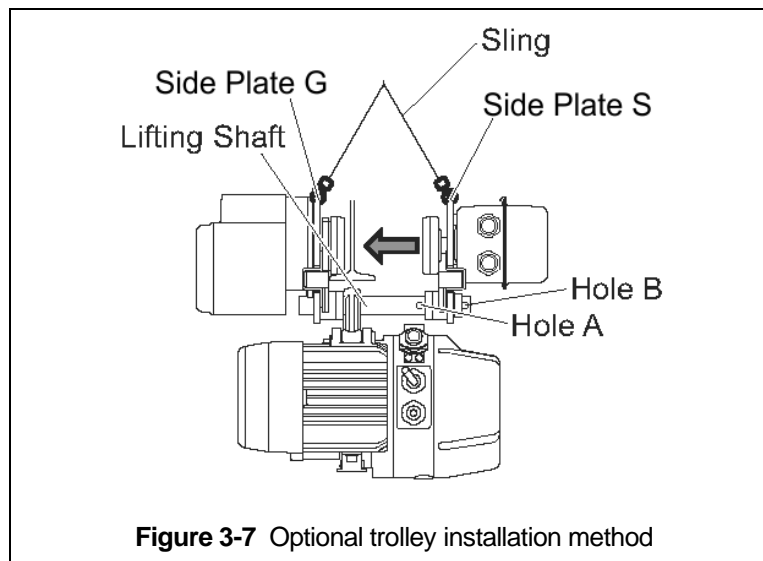



## 3.4 Electrical Connections

- 3.4.1 **⚠ CAUTION** Ensure that the voltage of the electric power supply is proper for the hoist or trolley. The SMR2Q trolley is voltage reconnectable between 115V or 230V through a device called the DPC (Dual Power Converter). Supplying the hoist with incorrect power supply could result in property damage and/or injury. Refer to **Section 3.4.7** for voltage change instructions.
- 3.4.2 **⚠ CAUTION** Do NOT apply electronic soft-start control or voltage varying controls to the SMR2Q trolley. Use of such devices may cause the motor brake and other electrical components to malfunction.
- 3.4.3 **⚠ DANGER** Before proceeding, ensure that the electrical supply for the hoist or trolley has been de-energized (disconnected). Lock out and tag out in accordance with ANSI Z244.1 "Personnel Protection -Lockout/Tagout of Energy Sources".
- 3.4.4 **⚠ DANGER** To avoid a shock hazard, **DO NOT** perform **ANY** mechanical or electrical maintenance on the trolley or hoist within 5 minutes of de-energizing (disconnecting) the trolley or hoist. This time allows the internal VFD capacitor to safely discharge.
- 3.4.5 **⚠ DANGER** Do Not remove power to the hoist or trolley during operation.
- 3.4.6 **⚠ CAUTION** All SMR2Q trolleys are equipped with a VFD. The VFD is used to control the high and low traversing speeds and accelerations. These speeds and accelerations come preset from the factory, 80/13 feet per minute. Speed (frequency) parameters can be customized. Refer to **Section 3.5.10** for trolley specific speed ranges and instructions and **Section 3.5.11** for trolley specific acceleration/deceleration ranges and instructions.
- 3.4.7 The following instructions apply to installations where an SEQ model electric hoist is installed on an SMR2Q trolley. In this case the hoist and trolley are controlled by a pendant with four push buttons – two for the hoist motion and two for the trolley motion.

**Pendant Cord** - The Pendant Cord directly connects to the trolley's Connection Box using a Cable Holder Assembly. Make this connection as follows:

- 1) Refer to **Figure 3-8**.
- 2) With 1 inch of the outer cable insulation extending beyond the cable packing, insert the cable into the Connection Box and screw together Cable Holder A and B.
- 3) Install the Strain Relief Cable to the Cord Support on the Bar Holder.
- 4) Inside the trolley's Connection Box, insert the 6 pin and 3 pin pendant connectors (white) into the CN13 connector and X21 connectors, respectively. Refer to the wiring diagram inside the control cover and connect wires correctly.
- 5) The spade terminals should be connected together (see **Figure 3-9**)

**Power Supply Cable Hoist Connection** – The Power Supply Cable connects directly to the trolley's Connection Box using Cable Holder Assembly. Make this connection as follows:

- 1) Refer to **Figure 3-8**.
- 2) With 1 inch of the outer cable insulation extending beyond the cable packing, insert the cable into the Connection Box and screw together Cable Holder A and B.
- 3) Refer to **Figure 3-10** and connect the black and white(115V)/red(230V) wires to terminals 1 and 3 on the terminal strip inside the Connection Box. Connect the ground wire (green with yellow stripe or solid green) to the ground terminal under the terminal strip.

**NOTICE** The conductor on terminal 3 should be white for 115V and red for 230V. If this is not the case, tape each end of the conductor with the appropriate color tape.

- 4) Install the Cable Support Assembly (pre-installed on the Power Supply Cable) onto the Cable Support Arm Assembly as shown in **Figure 3-11**.
- 5) Use care to avoid twisting or kinking the Power Supply Cable.

**Trolley to Hoist Connections** – The trolley connects to the hoist via short relay cables that are factory installed into the trolley Connection Box. . Make these connections as follows:

- 1) Refer to **Figure 3-8**.
- 2) With 1 inch of the outer cable insulation extending beyond the cable packing, insert each Relay Cable into the hoist and screw together Cable Holder A and B
- 3) Refer to the wiring diagram inside the trolley Connection Box Cover. Connect the white 6 pin connector from the Relay Cable for Operation to CN13 inside the hoist. Connect the wires from the Relay Cable for Power to the DPC according to wiring diagram.

**VOLTAGE CHANGE –**

**⚠ DANGER** Follow all preceding warnings in **Section 3.4** before performing a voltage change.

**For 115V Power Supply**

- 1) Refer to **Figure 3-10**.
- 2) Locate the DPC device directly next to the Variable Frequency Drive (VFD)
- 3) Ensure the white wire lead (labeled P1 at its origin) is connected to the CN3 (115V) location. If not, disconnect wire and relocate to the CN3 (115V) location.
- 4) Ensure voltage label on outside of the control cover reflects 115V.

**For 230V Power Supply**

- 1) Refer to **Figure 3-10**.
- 2) Locate the DPC device directly next to the Variable Frequency Drive (VFD)
- 3) Ensure the white wire lead (labeled P1 at its origin) is connected to the CN2 (230V) location. If not, disconnect wire and relocate to the CN2 (230V) location.
- 4) Ensure voltage label on outside of the control cover reflects 230V.
- 5) Mark the white conductor for terminal 3 on the power supply with red tape on both ends.

**Power Supply Cable Festooning** – The SMR2Q trolley is supplied with Cable Hangers for the Power Supply Cable. Make this connection as follows:

- 1) Refer to **Figure 3-11**.
- 2) Install the Cable Hangers onto the Power Supply Cable spacing them every 5 feet.
- 3) Install a Guide Wire system parallel to the beam. Pass the Guide Wire through the Cable Hangers and Wire Guide.
- 4) Make sure the Guide Wire is properly tensioned and the Power Supply Cable is not twisted or kinked.

3.4.8 Connection to Electrical Power Source - The white and black wires of the Power Supply Cable should be connected to an Electric Power Disconnect Switch or Circuit Breaker.

3.4.9 Fuse/Breaker Capacity -The power supply for the trolley and hoist should be equipped with current overload protection such as fuses, which should be selected for 110% to 120% of total listed full load amperage, and should be dual element time-delay fuses. Refer to the Nameplate SP on the trolley and hoist for the full load amperage draw of each and added the two values together for the total amperage.

3.4.10 **⚠ DANGER** Grounding - An improper or insufficient ground connection creates an electrical shock hazard when touching any part of the hoist or trolley. In the Power Supply Cable the ground wire will be either Green with Yellow stripe or solid Green. It should always be connected to a suitable ground connection. Do not paint the trolley wheel running surfaces of the beam as this can affect grounding.

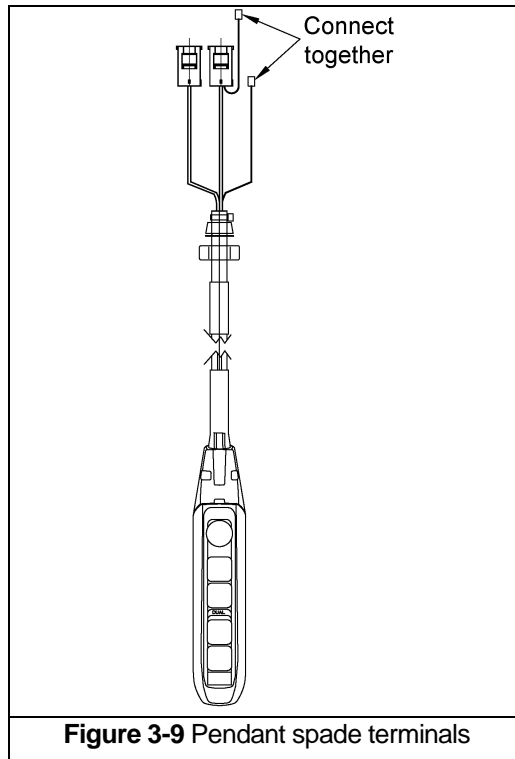
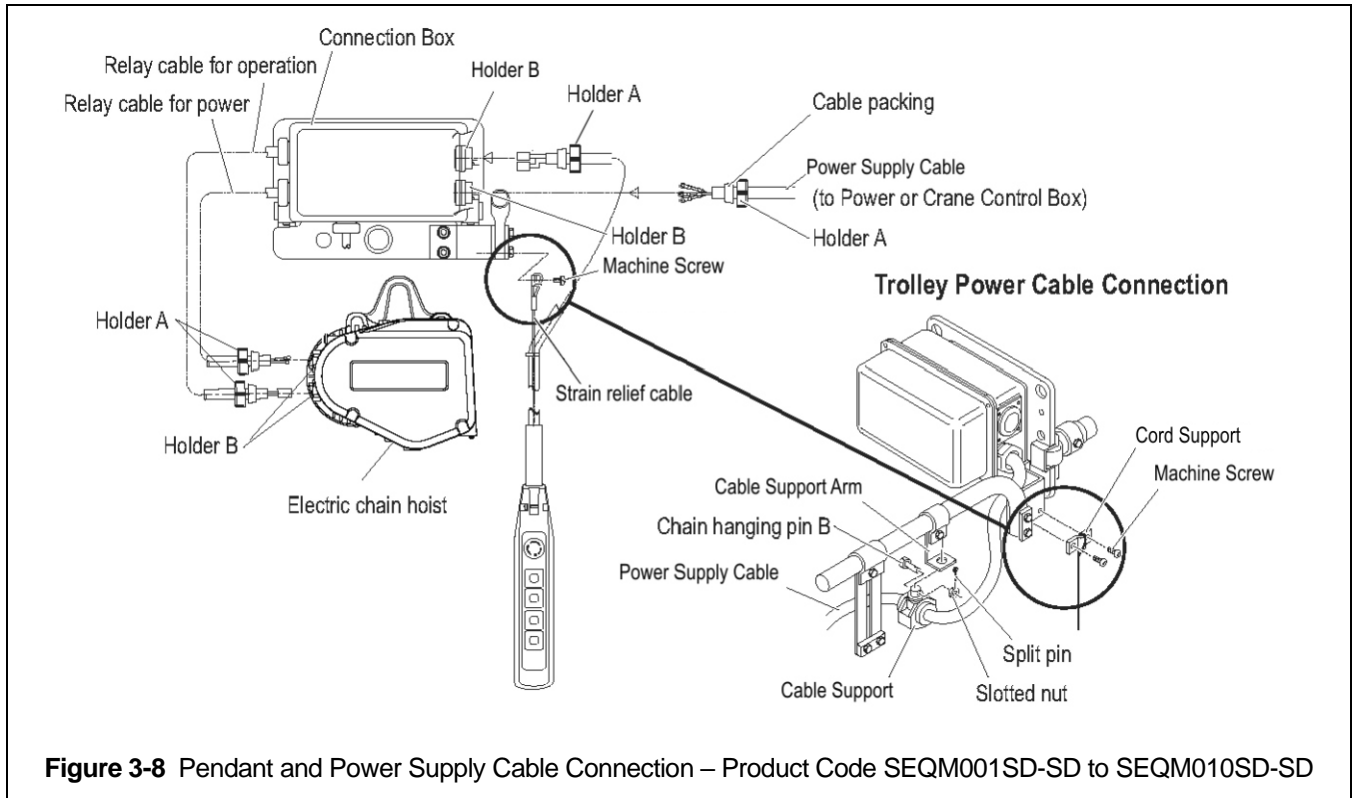

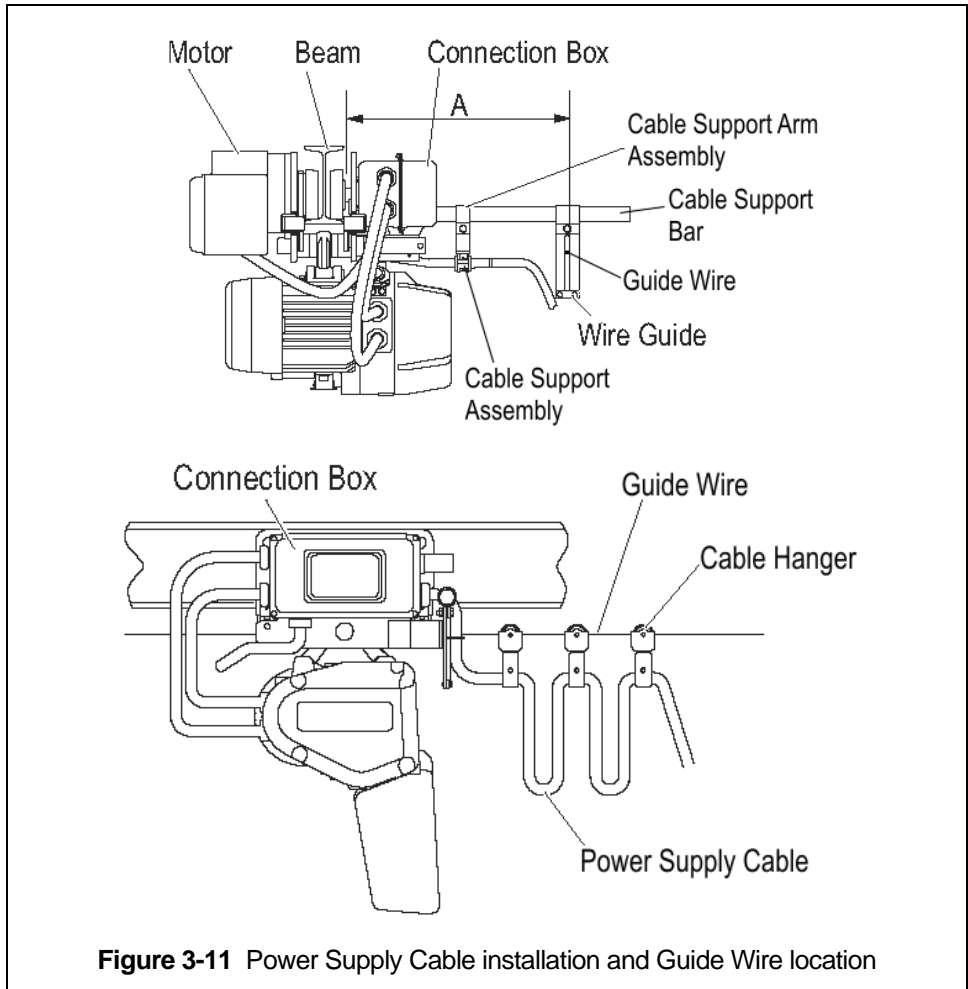
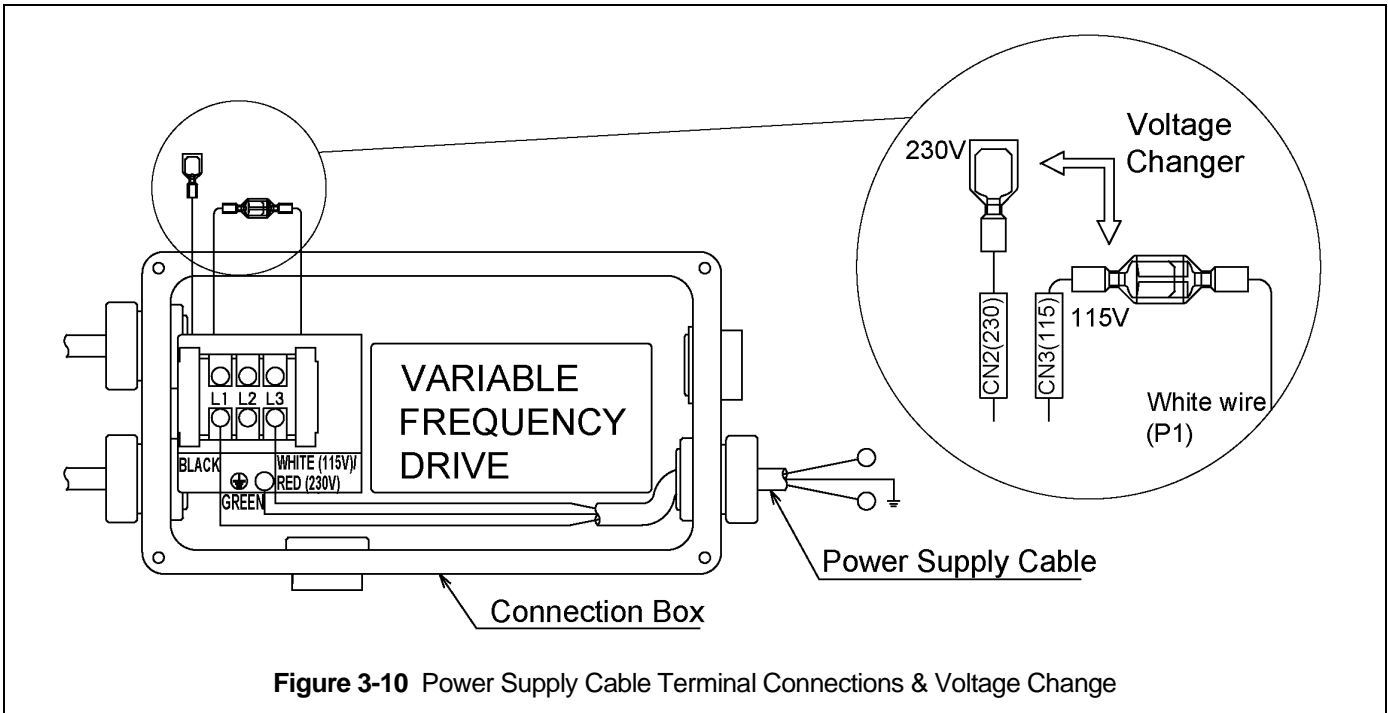

### 3.4.11 DPC Fuse Check

**⚠ DANGER** If the fuse has been damaged, completely disconnect the power and leave it for five minutes or longer. Then, remove the DPC and perform a continuity test on both fuse terminals. Refer to **Figure 3-12**.

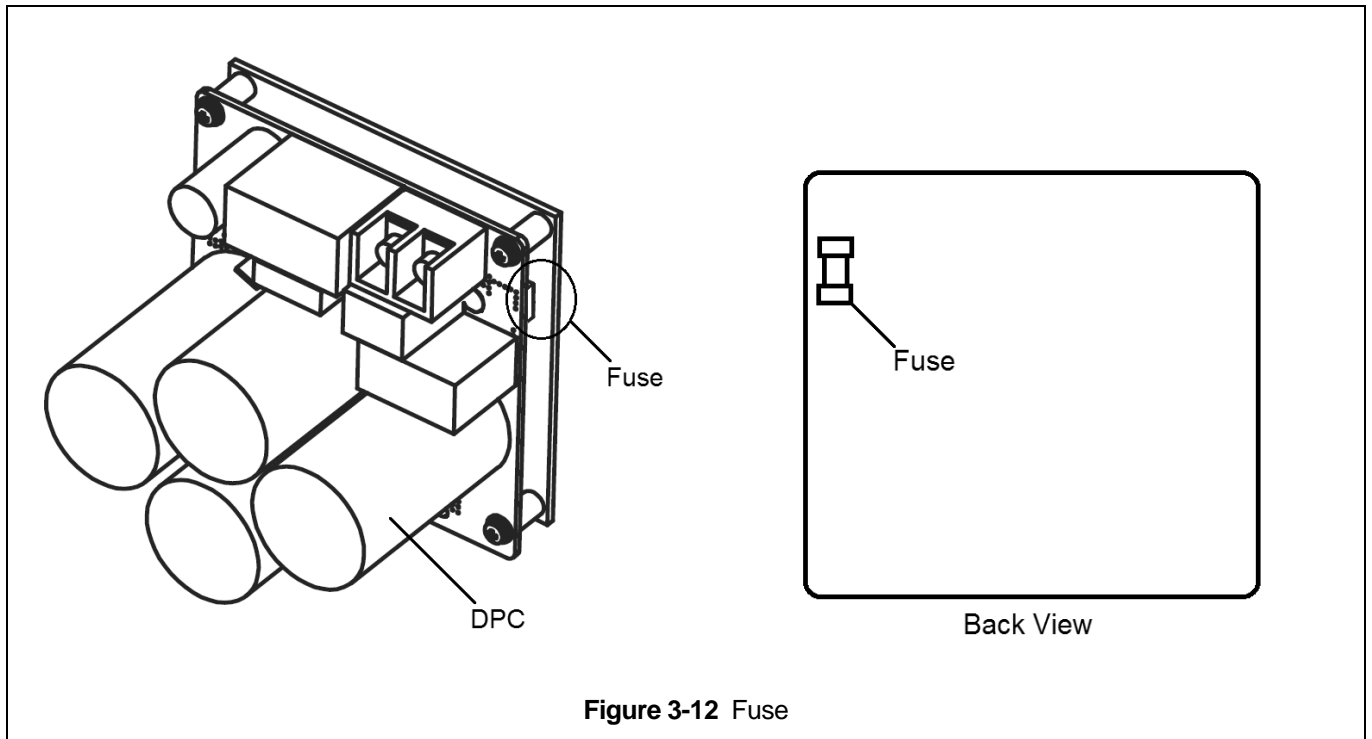

**Figure 3-12** Fuse

### 3.5 VFD Setup

3.5.1 **⚠ DANGER** To avoid a shock hazard, **DO NOT** perform **ANY** mechanical or electrical maintenance on the trolley or hoist within 5 minutes of de-energizing (disconnecting) the trolley or hoist. This time allows the internal VFD capacitor to safely discharge.

3.5.2 **⚠ WARNING** Do Not remove power to the hoist or trolley during operation.

3.5.3 All trolleys are equipped with a VFD. The VFD is used to control the high and low speeds and the accelerations/decelerations (accel/decel) of the trolley. These speeds, 80/13 and acceleration/decelerations, 4.0 seconds come preset from the factory. Speed (frequency) and acceleration/deceleration time parameters can be customized. Refer to **Section 3.5.10** for trolley specific speed ranges and instructions and **Section 3.5.11** for trolley specific acceleration/deceleration parameters and instructions.

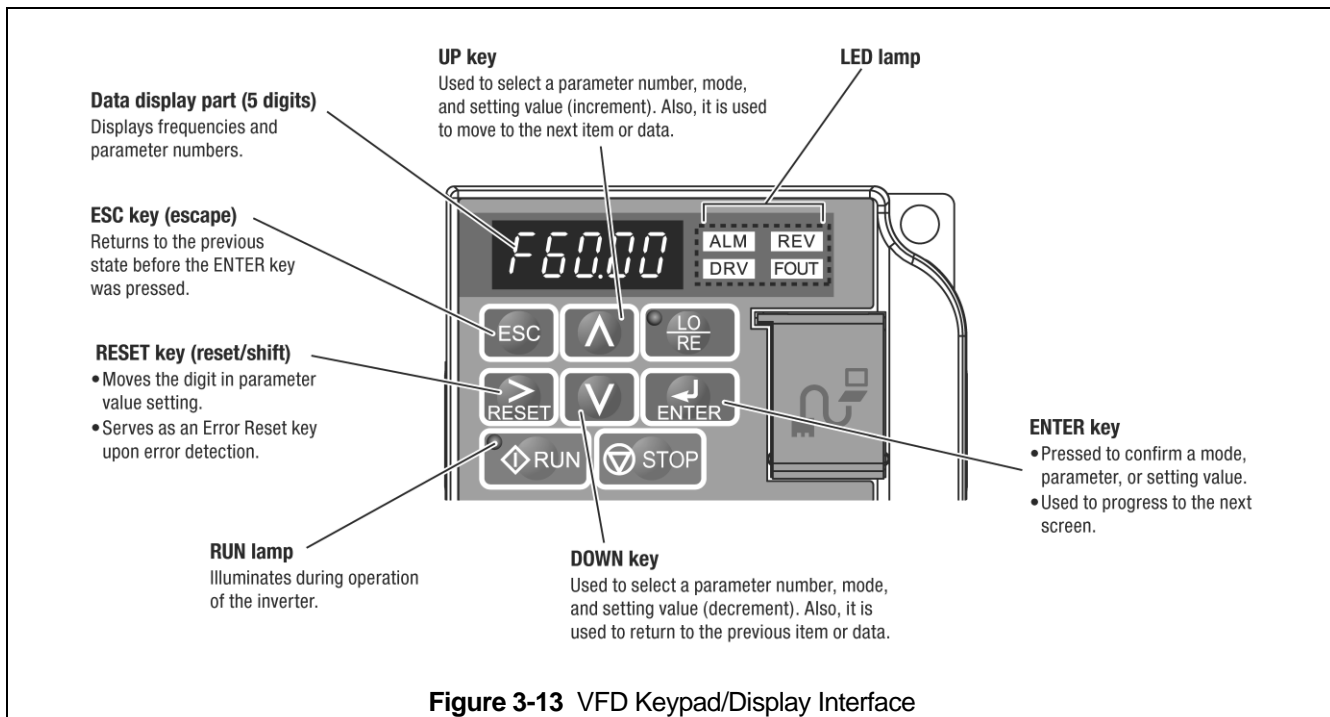

3.5.4 The VFD is controlled by a Keypad/Display Interface. Refer to **Figure 3-13** for Keypad/Display Interface functions and descriptions.



**Figure 3-13** VFD Keypad/Display Interface

3.5.5 When power is supplied to the trolley the VFD LED operator display will illuminate as shown **Table 3-3**.

**Table 3-3** LED Operator Display

No	Name	Description
Normal		The frequency command monitor is displayed in the data display part. <b>DRV</b> illuminates.
Error	 Example: Main circuit low voltage	The display varies depending on the error. <b>ALM</b> and <b>DRV</b> illuminate.

3.5.6 During operation the data display will exhibit illuminating or blinking data as shown in **Figure 3-14**.

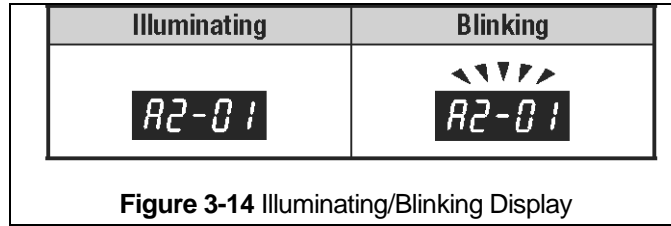

**Figure 3-14** Illuminating/Blinking Display

3.5.7 The digital display uses a seven segment character to form the specific characters used in the display. **Table 3-4** shows the corresponding digital characters to its English equivalent.

**Table 3-4** Digital Character Key





Character	LED display	Character	LED display	Character	LED display	Character	LED display
0	0	9	9	I	i	R	r
1	1	A	A	J	j	S	S
2	2	B	b	K	k	T	t
3	3	C	C	L	L	U	U
4	4	D	d	M	m*	V	v
5	5	E	E	N	n	W	w*
6	6	F	F	O	o	X	No display
7	7	G	G	P	P	Y	y
8	8	H	H	Q	q	Z	No display

3.5.8 The LED Lamp display provides trolley status. **Table 3-5** shows some of the status displays.

**Table 3-5** LED Lamp Display

Lamp	Illuminating	Blinking	Off
<b>ALM</b>	Upon error detection	<ul style="list-style-type: none"> <li>• Upon detection of minor failure</li> <li>• Upon detection of an OPE (operation error)</li> </ul>	Normal
<b>REV</b>	Inputting a reverse rotation command	-	Inputting a forward rotation command
<b>DRV</b>	In the drive mode	-	In the program mode
<b>FOUT</b>	Displaying output frequency (Hz)	-	-
Description in this document			

3.5.9 The Run Lamp display provides trolley “RUN” status. **Table 3-6** shows the various “RUN” displays.

Lamp	Illuminating	Blinking	Short blinking	Off
	During operation	<ul style="list-style-type: none"> <li>• During deceleration/ stop</li> <li>• Inputting a driving command with the frequency command 0</li> </ul>	<ul style="list-style-type: none"> <li>• During deceleration due to an emergency stop</li> <li>• During deceleration</li> <li>• During a stop due to driving interlock operation</li> </ul>	During a stop
Description in this document				

3.5.10 All trolleys have speed/frequency ranges that can be customized to a specific application. Refer to **Table 3-7** for specific trolley speed/frequency ranges. To set custom speeds for an application, follow the procedure in **Table 3-8**.

Product Code	Category*	Low (d1-02)		High (d1-02)	
		VFD Frequency (Hz)	Speed (ft/min)	VFD Frequency (Hz)	Speed (ft/min)
SMR2Q010SD	Standard	11.0	13.0	63.0	80.0
	Custom (Low: min./High: Max.)	6.7	8.0	63.0	80.0

\* Standard = The factory standard minimum and maximum speed/frequency range (6:1 ratio).

Custom = The minimum and maximum speed/frequency range (10:1 ratio).



**Table 3-8** Speed/Frequency Change Procedure

**⚠ CAUTION**

- Each trolley has a range of available speeds/frequencies (upper and lower limits).
- Any value outside the range listed in **Table 3-7** for your specific trolley is strictly prohibited.
- Speeds must be set such as Low [d1-01] and High [d1-02].
- After parameters are changed, a “no load” operational check must be performed.

Operational Step	VFD Display
1. Energize the trolley.	
2. Press  until the “Setup Mode” screen is displayed (blinking).	
3. Press  to display the parameter setting screen (blinking).	
4. Press  or  until the desired parameter is displayed (blinking). (Low Speed: d1-01, High Speed: d1-02)	
5. When you press , the current setting value is displayed (digit selected blinks). (Example Value: 9Hz)	
6. Press  to move the blinking digit to the desired digit. (Example Value: 9 blinks)	
7. Press  or  until the desired setting is displayed and press . (Example Value: 8Hz)	
8. Press  to confirm the new setting.	
9. The display will automatically return to the parameter screen (blinking). (As in Step 4.)	
10. Press  until the display returns to the initial screen. (As in Step 1.)	





















3.5.11 All trolleys have a acceleration/deceleration time parameter range that can be customized to a specific application. Refer to **Table 3-9** for specific trolley acceleration/deceleration time ranges. To set custom acceleration/deceleration times for an application, follow the procedure in **Table 3-10**.

Table 3-9 VFD Acceleration/Deceleration Time Parameter Ranges					
Item	Parameter No.	Initial Value	Unit	Setting Range	Remark
Acceleration Time	C1-01	4.0	Seconds	1.2 – 6.0	Set the same value to the three parameters
	C1-03				
	C1-07				
Deceleration Time	C1-02	4.0	Seconds	1.2 – 6.0	Set the same value to the three parameters
	C1-04				
	C1-08				

**Table 3-10** Acceleration/Deceleration Time Procedure

**⚠ CAUTION**

- Each trolley model has a range of acceleration/deceleration time parameters. Any value outside the range listed in **Table 3-9** for your specific trolley is strictly prohibited.
- After parameters are changed, a “no load” operational check must be performed.
- Example: Changing the C1-01(acceleration time) from 4.0 sec to 2.0 sec

Operational Step	VFD Display
1. Energize the trolley.	
2. Press  until the “Setup Mode” screen is displayed (blinking).	
3. Press  to display the parameter setting screen (blinking).	
4. Press  or  until the desired parameter is displayed (blinking).	
5. When you press  , the current setting value is displayed (digit selected blinks). (Example Value: 4 seconds)	
6. Press  to move the blinking digit to the desired digit. (Example Value: 4 blinks)	
7. Press  or  until the desired setting is displayed and press  .	
8. Press  to confirm the new setting.	
9. The display will automatically return to the parameter screen (blinking). (As in Step 4.)	
10. Press  until the display returns to the initial screen. (As in Step 1.)	

3.5.12 “Hbb” will appear on the VFD display when the Emergency Stop Button is depressed. Turn the Emergency Stop Button clockwise to unlock the controls and allow hoist operation.

## 3.6 Pre-operational Checks and Trial Operation

- 3.6.1 Refer to the trolley's Nameplate and record the Code, Lot and Serial Number in the space provided on the cover of this manual.
- 3.6.2 Refer to the hoist's owner's manual and perform all pre-operational checks for the hoist.
- 3.6.3 Perform pre-operational checks for the trolley:
- **⚠ WARNING** Confirm the adequacy of the rated capacity for all slings, chains, wire ropes and all other lifting attachments before use. Inspect all load suspension members for damage prior to use and replace or repair all damaged parts.
  - Ensure that trolley is properly installed on the beam, and stops for the trolley are correctly positioned and securely installed on the beam.
  - Ensure that all nuts, bolts and split pins (cotter pins) are sufficiently fastened.
  - Pull down on the Pendant and ensure that the Cord Strain Relief Cable takes the force, not the Pendant Cord.
  - **⚠ CAUTION** Check supply voltage before everyday use. If the voltage varies more than 10% of the rated value, electrical devices may not function normally.
- 3.6.4 Confirm proper operation.
- Before operating read and become familiar with **Section 4** - Operation.
  - Before operating ensure that the hoist (and trolley) meets the Inspection, Testing and Maintenance requirements of ANSI/ASME B30.16.
  - Before operating ensure that nothing will interfere with the full range of the hoist's (and trolley's) operation.
- 3.6.5 Proceed with trial operation to confirm proper operation.
- Verify that the controls agree with hoist direction. Make sure that depression of the Up button lifts the load chain and hook and depression of the Down button lowers the load chain and hook.
  - Operate the trolley through its full range of motion. Make sure the trolley runs smoothly and does not bind. Check the power supply and festoon system for proper operation.
  - Perform inspections per **Section 5.3**, "Frequent Inspections".

## 4.0 Operation

### 4.1 Introduction

#### **DANGER**

DO **NOT** WALK UNDER A SUSPENDED LOAD

#### **WARNING**

HOIST OPERATORS SHALL BE REQUIRED TO READ THE OPERATION SECTION OF THIS MANUAL, THE WARNINGS CONTAINED IN THIS MANUAL, INSTRUCTION AND WARNING LABELS ON THE HOIST OR LIFTING SYSTEM, AND THE OPERATION SECTIONS OF ANSI/ASME B30.16 and ANSI/ASME B30.10. THE OPERATOR SHALL ALSO BE REQUIRED TO BE FAMILIAR WITH THE HOIST AND HOIST CONTROLS BEFORE BEING AUTHORIZED TO OPERATE THE HOIST OR LIFTING SYSTEM.

HOIST OPERATORS SHOULD BE TRAINED IN PROPER RIGGING PROCEDURES FOR THE ATTACHMENT OF LOADS TO THE HOIST HOOK.

HOIST OPERATORS SHOULD BE TRAINED TO BE AWARE OF POTENTIAL MALFUNCTIONS OF THE EQUIPMENT THAT REQUIRE ADJUSTMENT OR REPAIR, AND TO BE INSTRUCTED TO STOP OPERATION IF SUCH MALFUNCTIONS OCCUR, AND TO IMMEDIATELY ADVISE THEIR SUPERVISOR SO CORRECTIVE ACTION CAN BE TAKEN.

HOIST OPERATORS SHOULD HAVE NORMAL DEPTH PERCEPTION, FIELD OF VISION, REACTION TIME, MANUAL DEXTERITY, AND COORDINATION.

HOIST OPERATORS SHOULD **NOT** HAVE A HISTORY OF OR BE PRONE TO SEIZURES, LOSS OF PHYSICAL CONTROL, PHYSICAL DEFECTS, OR EMOTIONAL INSTABILITY THAT COULD RESULT IN ACTIONS OF THE OPERATOR BEING A HAZARD TO THE OPERATOR OR TO OTHERS.

HOIST OPERATORS SHOULD **NOT** OPERATE A HOIST OR LIFTING SYSTEM WHEN UNDER THE INFLUENCE OF ALCOHOL, DRUGS, OR MEDICATION.

OVERHEAD HOISTS ARE INTENDED ONLY FOR VERTICAL LIFTING SERVICE OF FREELY SUSPENDED UNGUIDED LOADS. DO **NOT** USE HOIST FOR LOADS THAT ARE NOT LIFTED VERTICALLY, LOADS THAT ARE NOT FREELY SUSPENDED, OR LOADS THAT ARE GUIDED.

#### **NOTICE**

- Read ANSI/ASME B30.16 and ANSI/ASME B30.10.
- Read the hoist manufacturer's Operating and Maintenance Instructions.
- Read all labels attached to equipment.

The operation of an overhead hoist involves more than activating the hoist's controls. Per the ANSI/ASME B30 standards, the use of an overhead hoist is subject to certain hazards that cannot be mitigated by engineered features, but only by the exercise of intelligence, care, common sense, and experience in anticipating the effects and results of activating the hoist's controls. Use this guidance in conjunction with other warnings, cautions, and notices in this manual to govern the operation and use of your overhead hoist.

## 4.2 Shall's and Shall Not's for Operation

### **WARNING**

Improper operation of a hoist can create a potentially hazardous situation which, if not avoided, could result in death or serious injury, and substantial property damage. To avoid such a potentially hazardous situation **THE OPERATOR SHALL:**

- **NOT** operate a damaged, malfunctioning or unusually performing hoist.
- **NOT** operate a hoist until you have thoroughly read and understood Manufacturer's Operating and Maintenance Instructions or Manuals.
- Be familiar with operating controls, procedures, and warnings.
- **NOT** operate a hoist that has been modified without the manufacturer's approval or without certification that it is in conformity with ANSI/ASME B30 volumes.
- **NOT** lift more than rated load for the hoist.
- **NOT** use hoist with twisted, kinked, damaged, or worn load chain.
- **NOT** use the hoist to lift, support, or transport people.
- **NOT** lift loads over people.
- **NOT** operate a hoist unless all persons are and remain clear of the supported load.
- **NOT** operate unless load is centered under hoist.
- **NOT** attempt to lengthen the load chain or repair damaged load chain.
- Protect the hoist's load chain from weld splatter or other damaging contaminants.
- **NOT** operate hoist when it is restricted from forming a straight line from hook to support in the direction of loading.
- **NOT** use load chain as a sling or wrap load chain around load.
- **NOT** apply the load to the tip of the hook or to the hook latch.
- **NOT** apply load unless the load chain is properly seated in its grooves.
- **NOT** apply load if bearing prevents equal loading on all load-supporting chain.
- **NOT** operate beyond the limits of the load chain travel.
- **NOT** leave load supported by the hoist unattended unless specific precautions have been taken.
- **NOT** allow the load chain or hook to be used as an electrical or welding ground.
- **NOT** allow the load chain or hook to be touched by a live welding electrode.
- **NOT** remove or obscure the warnings on the hoist.
- **NOT** operate a hoist on which the safety placards or decals are missing or illegible
- **NOT** operate a hoist unless it has been securely attached to a suitable support.
- **NOT** operate a hoist unless load slings or other approved single attachments are properly sized, and seated in the hook saddle.
- **NOT** use the hoist in such a way that could result in shock or impact loads being applied to the hoist.
- **NOT** turn off the power when a load is suspended.
- Take up slack carefully – make sure load is balanced and load-holding action is secure before continuing.
- Shut down a hoist that malfunctions or performs unusually and report such malfunction.
- Make sure hoist limit switches function properly.
- Warn personnel before lifting or moving a load.
- Warn personnel of an approaching load.

## CAUTION

Improper operation of a hoist can create a potentially hazardous situation which, if not avoided, could result in minor or moderate injury, or property damage. To avoid such a potentially hazardous situation **THE OPERATOR SHALL:**

- Maintain a firm footing or be otherwise secured when operating the hoist.
- Check brake function by tensioning the hoist prior to each lift operation.
- Use hook latches. Latches are to retain slings, chains, etc. under slack conditions only.
- Make sure the hook latches are closed and not supporting any parts of the load.
- Make sure the load is free to move and will clear all obstructions.
- Avoid swinging the load or hook.
- Make sure hook travel is in the same direction as shown on controls.
- Inspect the hoist regularly, replace damaged or worn parts, and keep appropriate records of maintenance.
- Use the hoist manufacturer's recommended parts when repairing the unit.
- Lubricate load chain per hoist manufacturer's recommendations.
- **NOT** use the hoist load limiting or warning device to measure load.
- **NOT** use limit switches as routine operating stops. They are emergency devices only.
- **NOT** allow your attention to be diverted from operating the hoist.
- **NOT** allow the hoist to be subjected to sharp contact with other hoists, structures, or objects through misuse.
- **NOT** adjust or repair the hoist unless qualified to perform such adjustments or repairs.

### 4.3 Trolley and Hoist Controls

- 4.3.1 Emergency Stop Button – Press the Emergency Stop Button to perform an emergency stop and lock-out of hoist motion controls or to reset the VFD as shown in **Figure 4-1**. Turn the Emergency Stop Button clockwise to unlock the controls and allow hoist operation. “Hbb” will appear on the VFD display when the Emergency Stop Button is depressed.
- 4.3.2 Dual Speed Pendant Control – For low speed depress the button to the first step and for high speed depress the button fully to the second step. Use the Up button to raise the hoist's hook or the Down button to lower the hoist's hook as shown in **Figure 4-1**. Depress the Forward and Reverse buttons to move the trolley horizontally. To stop motion release the buttons.
- 4.3.3 **⚠ CAUTION** Make sure the hoist and/or trolley motor completely stops before reversing direction.

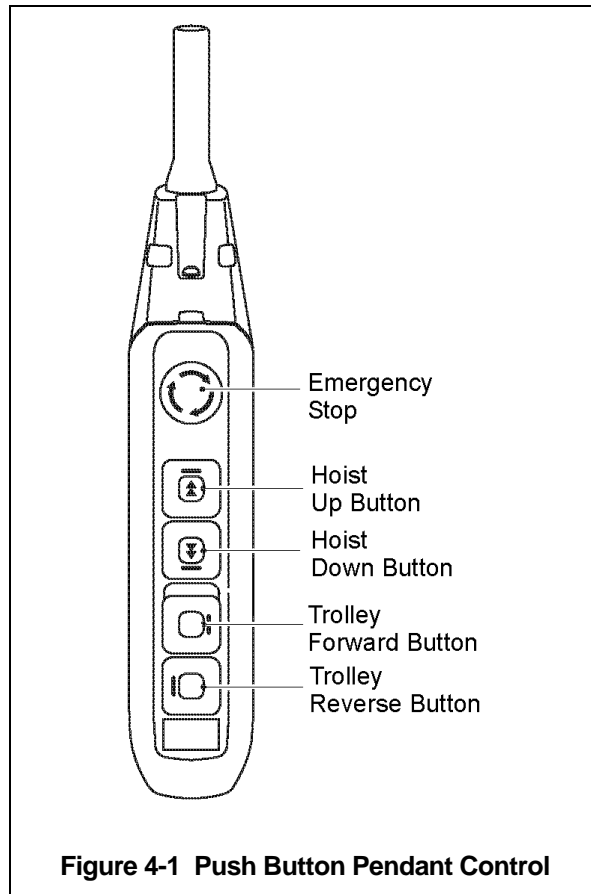

## 5.0 Inspection

### 5.1 General

- 5.1.1 The inspection procedure herein is based on ANSI/ASME B30.16. The following definitions are from ANSI/ASME B30.16 and pertain to the inspection procedure below.
- **Designated Person** - a person selected or assigned as being competent to perform the specific duties to which he/she is assigned.
  - **Qualified Person** - a person who, by possession of a recognized degree or certificate of professional standing, or who, by extensive knowledge, training, and experience, has successfully demonstrated the ability to solve or resolve problems relating to the subject matter and work.
  - **Normal Service** - that distributed service which involves operation with randomly distributed loads within the rated load limit, or uniform loads less than 65% of rated load for not more than 25% of the time.
  - **Heavy Service** - that service which involves operation within the rated load limit which exceeds normal service.
  - **Severe Service** - that service which involves normal or heavy service with abnormal operating conditions.

### 5.2 Inspection Classification

- 5.2.1 Initial Inspection - prior to initial use, all new, re-installed, altered, or modified trolleys shall be inspected by a designated person to ensure compliance with the applicable provisions of this manual.
- 5.2.2 Inspection Classification - the inspection procedure for trolleys in regular service is divided into two general classifications based upon the intervals at which inspection should be performed. The intervals in turn are dependent upon the nature of the critical components of the trolley and the degree of their exposure to wear, deterioration, or malfunction. The two general classifications are herein designated as FREQUENT and PERIODIC, with respective intervals between inspections as defined below.
- 5.2.3 FREQUENT Inspection - visual examinations by the operator or other designated personnel with intervals per the following criteria:
- Normal service - monthly
  - Heavy service - weekly to monthly
  - Severe service - daily to weekly
  - Special or infrequent service - as recommended by a qualified person before and after each occurrence.
- 5.2.4 PERIODIC Inspection - visual inspection by a designated person with intervals per the following criteria:
- Normal service - yearly
  - Heavy service - semiannually
  - Severe service – quarterly
  - Special or infrequent service - as recommended by a qualified person before the first such occurrence and as directed by the qualified person for any subsequent occurrences.



### 5.3 Frequent Inspection

- 5.3.1 Inspections should be made on a FREQUENT basis in accordance with **Table 5-1**, “Frequent Inspection.” Included in these FREQUENT Inspections are observations made during operation for any defects or damage that might appear between Periodic Inspections. Evaluation and resolution of the results of FREQUENT Inspections shall be made by a designated person such that the trolley is maintained in safe working condition.

<b>Table 5-1</b> Frequent Inspection
All functional operating mechanisms for proper operation, proper adjustment, and unusual sounds.
Trolley braking system for proper operation
Hoist(s) in accordance with ANSI/ASME B30.16
Upper Limit Devices in accordance with ANSI/ASME B30.16
Hook(s) and hook latches in accordance with ANSI/ASME B30.10

### 5.4 Periodic Inspection

- 5.4.1 Inspections should be made on a PERIODIC basis in accordance with **Table 5-2**, “Periodic Inspection.” Evaluation and resolution of the results of PERIODIC Inspections shall be made by a designated person such that the trolley is maintained in safe working condition.
- 5.4.2 For inspections where load suspension parts of the trolley are disassembled, a load test per ANSI/ASME B30.16 must be performed on the trolley after it is re-assembled and prior to its return to service.

<b>Table 5-2</b> Periodic Inspection
Requirements of frequent inspection.
Loose or missing bolts, nuts, pins or rivets.
Worn, cracked, or distorted parts such as pins, bearings, wheels, shafts, gears, rollers, yokes, and bumpers.
Excessive wear of brake system parts
Deterioration of electrical components such as controllers, switches, contacts, pushbuttons.
Proper function of motion limit devices that interrupt power or cause a warning to be activated.
Function, instruction and warning labels for legibility and placement.

### 5.5 Occasionally Used Trolleys

- 5.5.1 Trolleys that are used infrequently shall be inspected as follows prior to placing in service:
- Trolley Idle More Than 1 Month, Less Than 1 Year: Inspect per FREQUENT Inspection criteria in **Section 5.3**.
  - Trolley Idle More Than 1 Year: Inspect per PERIODIC Inspection criteria in Section 5.4

### 5.6 Inspection Records

- 5.6.1 Dated inspection reports and records should be maintained at time intervals corresponding to those that apply for the hoist’s PERIODIC interval per **Section 5.2.4**. These records should be stored where they are available to personnel involved with the inspection, maintenance, or operation of the trolley.

## 5.7 Inspection Methods and Criteria

- 5.7.1 This section covers the inspection of specific items. The list of items in this section is based on those listed in ANSI/ASME B30.16 for Frequent and Periodic Inspection. In accordance with ANSI/ASME B30.16, these inspections are not intended to involve disassembly of the trolley. Rather, disassembly for further inspection would be required if frequent or periodic inspection results so indicate. Such disassembly and further inspection should only be performed by a qualified person trained in the disassembly and re-assembly of the trolley.

<b>Table 5-3</b> Trolley Inspection Methods and Criteria			
<b>Item</b>	<b>Method</b>	<b>Criteria</b>	<b>Action</b>
Functional operating mechanisms.	Visual, Auditory	Mechanisms should be properly adjusted and should not produce unusual sounds when operated.	Repair or replace as required.
Braking System Operation	Function	Trolley must come to a smooth stop within 10% of its traveling speed when the pendant button is released.	Repair or replace as required.
Housing and Mechanical Components	Visual, Auditory, Vibration, Function	Trolley components including, suspension shafts, track wheels, track wheel axles, clevises, connection yokes, suspension bolts, shafts, gears, bearings, pins, rollers, and bumpers should be free of cracks, distortion, significant wear and corrosion. Evidence of same can be detected visually or via detection of unusual sounds or vibration during operation.	Replace.
Side Plates	Visual	Must be free of significant deformation	Replace.
Bolts, Nuts, Snap Rings, and Split Pins	Visual, Check with Proper Tool	Bolts, nuts, snap rings and split pins should not be loose.	Tighten or replace as required.
Track Wheel - Tread	Visual, Measure	Diameter of the inside and outside tread surface should not be less than the discard value shown in <b>Table 5-4</b> .	Replace.
Track Wheel - Gear	Visual	Teeth should not be cracked, damaged, or excessively worn.	Replace.
Side Rollers - Wear	Visual, Measure	Diameter should not be less than the discard value shown in <b>Table 5-5</b> .	Replace.
Suspension Shaft	Visual, Measure	Suspension shaft should not be bent. Diameter should not be worn by 5% or more.	Replace.
Motor Brake	Visual, Measure	Brake lining dimension "A" should not be less than discard value listed in <b>Table 5-6</b> . Refer to <b>Section 6.3</b> for gaining access to motor brake and inspection procedures. Braking surfaces should be clean, free of grease/oil and should not be glazed.	Replace.
VFD	Visual, Function	There should be no fault codes (Reference <b>Section 3.5</b> )	Replace as needed.

**Table 5-3** Trolley Inspection Methods and Criteria

Item	Method	Criteria	Action
Pendant - Switches	Function	Depressing and releasing push buttons should make and break contacts in switch contact block and result in corresponding electrical continuity or open circuit. Push-buttons should be interlocked either mechanically or electrically to prevent simultaneous energization of circuits for opposing motions (e.g. forward and reverse).	Repair or replace as necessary.
Pendant - Housing	Visual	Pendant housing should be free of cracks and mating surfaces of parts should seal without gaps.	Replace.
Pendant - Wiring	Visual	Wire connections to switches in pendant should not be loose or damaged.	Tighten or repair
Pendant And Power Cords	Visual, Electrical Continuity	Surface of cord should be free from nicks, gouges, and abrasions. Each conductor in cord should have 100% electrical continuity even when cord is flexed back-and-forth. Pendant Cord Strain Relief Cable should absorb all of the load associated with forces applied to the pendant.	Replace.
Electrical Plugs, Sockets and Fittings	Visual	Electrical Plugs, Sockets and Fittings should not be cracked or damaged.	Repair or replace as necessary.
Cable Hangers	Visual	Cable Hangers should not be damaged or significantly worn. Movement should be smooth and should not cause the Power Supply Cable to twist or kink.	Repair or replace as necessary.
Pendant - Labels	Visual	Labels denoting functions should be legible.	Replace.
Warning Labels	Visual	Warning Labels should be affixed to the pendant cord (see <b>Section 1.2</b> ) and they should be legible.	Replace.
Trolley Capacity Label	Visual	The label that indicates the capacity of the trolley should be legible and securely attached to the trolley.	Replace.
Nameplates	Visual	The nameplates that indicate the trolley model, speed and motor data should be legible and securely attached to the trolley.	Replace
DPC – Heat Sink	Visual	The heat sink with the DPC should not be bent.	Replace.
DPC board – voltage terminals	Visual	Spade terminals should be securely connected to the proper voltage terminal on the DPC board.	Secure terminals.

**Table 5-4** Track Wheel Wear Dimensions

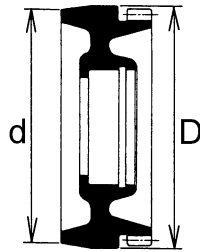

Note: Track wheels are for flat and tapered flanges.

Capacity (Ton)	"d" Dimension inch (mm)		"D" Dimension inch (mm)	
	Standard	Discard	Standard	Discard
1/8, 1/4, 1/2 and 1	3.60 (91.5)	3.44 (87.5)	3.74 (95)	3.58 (91)

**Table 5-5** Side Roller Wear Dimensions

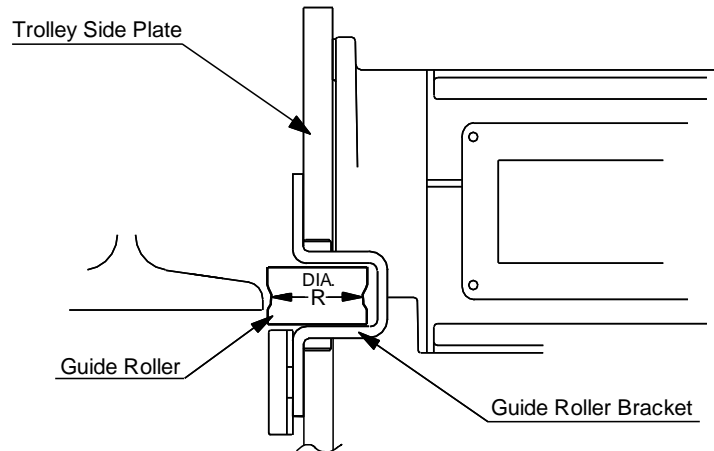

Capacity (Ton)	"R" Dimension inch (mm)	
	Standard	Discard
1/8, 1/4, 1/2 and 1	1.50 (38)	1.46 (37)

**Table 5-6** Motor Brake Wear Dimensions

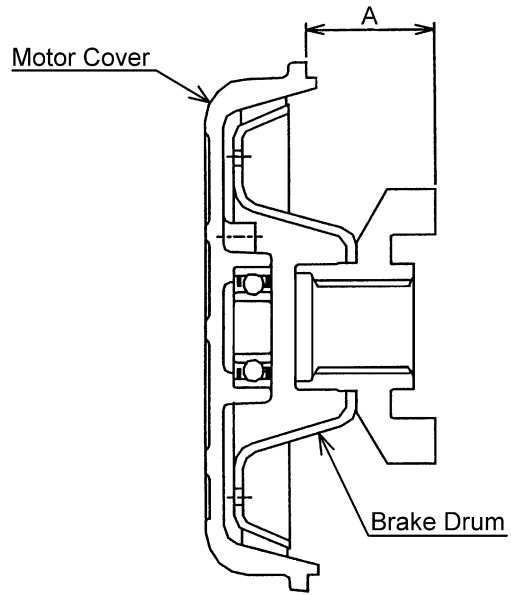

Capacity (Ton)	"A" Dimension - inch (mm)	
	Standard	Discard
1/8, 1/4, 1/2 and 1	1.28 (32.5)	1.22 (31.0)

## 6.0 Maintenance & Handling

### 6.1 Count/Hour Meter

#### 6.1.1 Displaying of Numbers of Starts and Hours of Operation

















- The VFD has a Count/Hour function built into the parameters. Refer to **Table 6-1** for parameter identification. Refer to **Table 6-2** for Count/Hour access procedure.

**Table 6-1** VFD Count/Hour Parameter Identification

Parameter	Name	Discription
U7-01	Number of Starts (Higher Order)	The number of starts in the <b>down</b> direction x 1,000. Up to 10,000 units are displayed. Display of "1" = 1,000 starts. Display of "10,000" = 10,000,000 starts
U7-02	Number of Starts (Lower Order)	The number of starts in the <b>down</b> direction under 1,000 starts (1 to 999). One start will register a "1" in the display. When 1,000 starts are reached, the value of U7-01 is incremented by 1 and the value of U7-02 is reset to 0.
U7-03	Hours of Operation	The number of hours of operation in both the <b>up</b> and <b>down</b> directions. One hour will register a "1" in the display. Up to 65535 hours are displayed.

- Example using **Table 6-1**:
  - U7-01 displays "81", U7-02 displays "567", U7-03 displays "122"
  - Number of Starts (down) = 81,567
  - Number of Operated Hours = 122

**Table 6-2** VFD Count/Hour Access Procedure

Operational Step	VFD Display
1. Energize the hoist.	
2. Press  until the "Monitor" screen is displayed (blinking).	
3. Press  to display the parameter setting screen an then press  to move from "01" to "U1".	
4. Press  or  until the display reads "U7" (left value blinking).	
5. Press  and  or  to select the specific "Monitor" parameter (right vlaue blinking). (Example: U7-03 –Hours of Operation)	
6. Press  to display the current parameter value. (Example: 75 Hours)	
7. Press  until the dplay returns to the initial screen. (As in Step 1.)	

- 6.1.2 Gear Lubricant – The Trolley C/H Meter can be used in conjunction with the average operation of the trolley to estimate when the gear lubricant should be changed. Refer to **Section 6.2.3**.
- 6.1.3 You are encouraged to use the Trolley Count/Hour Meter in conjunction with your experience with the trolley's application and usage to develop a history upon which to gage and fine tune your maintenance program for the trolley.

## 6.2 Lubrication

- 6.2.1 Lubricate the following trolley components with NLGI (National Lubricating Grease Institute) #2 or equivalent grease.
- 6.2.2 Track Wheel Gear – Clean and re-grease the Track Wheel gears and motor output pinion every three months (more frequently for heavier usage or severe conditions). Do not use an excessive amount of grease and avoid getting any grease on the running surfaces of the Track Wheels or the beam.
- 6.2.3 Gear Box – The reduction gearing in the motor should be cleaned and lubricated at least once per year for normal usage. Clean and lubricate the reduction gear assembly more frequently for heavier usage or severe conditions. Gain access to the gears by removing the four bolts that mount the motor assembly to the trolley Side Plate. Make sure to properly orient and reuse the neoprene gasket between the motor and Side Plate.
- 6.2.4 Suspension Pins, Bolts and Shafts – Grease at least twice per year for normal usage (more frequently for heavier usage or severe conditions).

## 6.3 Brake

- 6.3.1 The trolley motor brake is NOT adjustable.
- 6.3.2 Motor Brake Removal – Remove the four Bolts that attach the Motor Cover to the Motor Frame. Carefully remove the Motor Cover, brake components, and Stator.
- 6.3.3 Brake Lining Inspection – The brake lining is designed for a long life and should provide years of trouble-free service. If the brake lining is being inspected due to excessive trolley drift during operation (see **Section 5.7**), disassemble the motor brake and inspect all motor brake parts. Braking surfaces should be clean, free of grease/oil and should not be glazed. Replace the Brake Drum and/or Motor Cover if necessary. For normal inspections, the Brake Lining and Motor Cover wear should be measured as follows.
  - 1) Refer to **Table 5-6**.
  - 2) Measure the distance "A" using calipers and a straight edge. Make sure the Brake Drum is square against the Motor Cover. Place the straight edge across the edge of the Brake Drum and measure from the straight edge to the mounting face of the Motor Cover.
  - 3) Compare the measurement with the values listed in **Table 5-6**. Replace the Brake Drum and/or Motor Cover if the "A" measurement is smaller than the discard limit.
- 6.3.4 Motor Brake Installation - After the brake is inspected, carefully place the Stator and brake components into the Motor Frame. Be sure to reseal the Motor Cover to Motor Frame surface using a small bead of liquid (hi-temperature) sealant. Install the Motor Cover attachment bolts.

## 6.4 Storage

- 6.4.1 The storage location should be clean and dry.
- 6.4.2 Care should be take to not damage any of the electrical power cords or fittings.

## 6.5 Outdoor Installation

- 6.5.1 For trolley installations that are outdoors, the trolley **MUST BE** covered and protected from the weather at all times.
- 6.5.2 Possibility of corrosion on components of the trolley increases for installations where salt air and high humidity are present. The trolley may require more frequent lubrication. Make frequent and regular inspections of the unit's condition and operation.
- 6.5.3 For trolley installations where temperature variations introduce condensation into the trolley additional inspection and more frequent lubrication may be required.
- 6.5.4 Refer to **Section 2.1.3** for allowable environmental conditions.

## 6.6 Operational Environment

### 6.6.1 Non-conforming environment

A non-conforming environment is defined as one with any or all of the following.

- Explosive gases or vapor.
- Organic solvents or volatile powder
- Excessive amounts of powder and dust of general substances
- Excessive amount of acids or salts.



## 7.0 Troubleshooting

### **⚠ WARNING**

#### **HAZARDOUS VOLTAGES ARE PRESENT IN THE TROLLEY AND IN CONNECTIONS BETWEEN COMPONENTS.**

Before performing ANY maintenance on the equipment, de-energize the supply of electricity to the equipment, and lock and tag the supply device in the de-energized position. Refer to ANSI Z244.1, "Personnel Protection – Lockout/Tagout of Energy Sources."

To avoid a shock hazard, **DO NOT** perform **ANY** mechanical or electrical maintenance on the trolley or hoist within 5 minutes of de-energizing (disconnecting) the trolley or hoist. This time allows the internal VFD capacitor to safely discharge.

Only trained and competent personnel should inspect and repair this equipment.

### **NOTICE**

Do Not perform "withstand voltage" test or "insulation resistance" measurement (megger) with the VFD connected.

Do Not remove power to the hoist or trolley during operation.

Do Not connect power to the output of the VFD.

When handling VFD provide ESD protection.

**Table 7-1 Troubleshooting Guide**

Symptom	Cause	Remedy
Trolley will not operate	Loss of power	Check circuit breakers, switches, fuses and connections on power lines/cable.
	Wrong voltage or frequency	Check voltage and frequency of power supply against the rating on the nameplate of the motor.
	Motor overheated and thermal overload protector has tripped	See Troubleshooting Problem "Motor or brake overheating".
	Improper, loose, or broken wire in trolley electrical system	Shut off power supply, check wiring connections in the trolley switch box, on hoist control panel and inside push-button pendant.
	Faulty VFD	Check fault codes (Reference Section 3.5). Reset VFD by pressing the Emergency Stop button on the pendant. Replace as needed.
	Emergency Stop Depressed on Push Button Pendant Control	"Hbb" will appear on the VFD display when the Emergency Stop Button is depressed. Turn the Emergency Stop Button clockwise to unlock the controls and allow hoist operation.
	Motor burned out	Replace motor frame/stator, shaft/rotor, and any other damaged parts.
	DPC fuse blown out	Check the continuity of the fuse (Reference Section 3.4.11). Replace DPC if necessary.

**Table 7-1 Troubleshooting Guide**

<b>Symptom</b>	<b>Cause</b>	<b>Remedy</b>
Trolley drifts excessively when stopping	Motor brake not holding	Clean and inspect brake lining. Replace if necessary
	VFD Deceleration parameter adjusted incorrectly	Readjust VFD Deceleration parameter (Reference Section 3.5.11).
Motor or brake overheating	Excessive duty cycle	Reduce frequency of trolley movement.
	Extreme external heating	Above an ambient temperature of 140°F, the frequency of trolley operation must be reduced to avoid overheating of the motor. Special provisions should be made to ventilate the trolley or otherwise shield it from the heat.
Trolley operates intermittently	Collectors making poor contact	Check movement of spring loaded arm, weak spring, connections, and shoe. Replace as needed.
	Faulty VFD	Check fault codes (Reference Section 3.5). Replace as needed.
	Loose connection in circuit	Check all wires and terminals for bad connections. Replace as needed.
	Broken conductor in Pendant Cord	Check for intermittent continuity in each conductor the Pendant Cord. Replace entire Pendant Cord if continuity is not constant.
Uneven/unsteady traversing motion or Strange noise	Check the hoist suspension & shaft assembly	"Check the number of spacers and their assembled positions." Assemble correctly as needed.
	Deformation of wheel	Check the distortion of wheel and damage of running surface. Replace the wheel as needed.
	Deterioration of wheel bearing	Check if rolling noise sounds when the wheel is rotating. Replace the wheel bearing as needed.
Wheel unable to rotate	Locking of brake	Disassemble the motor cover. Remove rust or debris.

## **8.0 Warranty**

All products sold by Harrington Hoists, Inc. are warranted to be free from defects in material and workmanship from date of shipment by Harrington for the following periods:

- 1 year – Electric and Air Powered Hoists (excluding (N)ER2 Enhanced Features Models and EQ/SEQ Models ), Powered Trolleys, Powered Tiger Track Jibs and Gantries, Crane Components, Below the Hook Devices, Spare / Replacement Parts**
- 2 years – Manual Hoists & Trolleys, Beam Clamps**
- 3 years – (N)ER2 Enhanced Features Hoists, EQ/SEQ Hoists, and RY Hoists**
- 5 years – Manual Tiger Track Jibs and Gantries, TNER, EQ/SEQ, and RY Hoist Motor Brakes**
- 10 years – (N)ER2 “The Guardian” Smart Brake**

The product must be used in accordance with manufacturer’s recommendations and must not have been subject to abuse, lack of maintenance, misuse, negligence, or unauthorized repairs or alterations.

Should any defect in material or workmanship occur during the above time period in any product, as determined by Harrington Hoist’s inspection of the product, Harrington Hoists, Inc. agrees, at its discretion, either to replace (not including installation) or repair the part or product free of charge and deliver said item F.O.B. Harrington Hoists, Inc. place of business to customer.

Customer must obtain a Return Goods Authorization as directed by Harrington or Harrington’s published repair center prior to shipping product for warranty evaluation. An explanation of the complaint must accompany the product. Product must be returned freight prepaid. Upon repair, the product will be covered for the remainder of the original warranty period. Replacement parts installed after the original warranty period will only be eligible for replacement (not including installation) for a period of one year from the installation date. If it is determined there is no defect, or that the defect resulted from causes not within the scope of Harrington’s warranty, the customer will be responsible for the costs of returning the product.

Harrington Hoists, Inc. disclaims any and all other warranties of any kind expressed or implied as to the product’s merchantability or fitness for a particular application. Harrington will not be liable for death, injuries to persons or property or for incidental, contingent, special or consequential damages, loss or expense arising in connection with the use or inability whatever, regardless of whether damage, loss or expense results from any act or failure to act by Harrington, whether negligent or willful, or from any other reason.

**This Page Intentionally Left Blank**

## 9.0 Parts List

When ordering parts, please provide the trolley code number, lot number and serial number located on the hoist name plate (see fig. below).

Reminder: Per sections 1.1 and 3.6.1 to aid in ordering parts and Product Support, record the trolley code number, lot number and serial number in the space provided on the cover of this manual.

• Trolley Spec./Especificación del Carro/			
Sp#. Appareil de Chariot			
• Code / Código / Code:			
• Traveling Speed / Velocidad de trayecto /			
Vitesse de déplacement:		ft/min	
		m/min	
• Input power/Potencia de entrada/Courant puissance			
• Phase / Fase / Phase: 1			
Hz	V	A	
• Lot No. / N.º de lote / N.º de lot:			
• Serial No./N.º de serie/N.º de série:			
• Motor Spec./Especificación del motor/Sp# moteur			
• Phase / Fase / Phase: 3			
• IP55			
• Rating / Clasificación/ Evaluation: 27/13%ED 240C/h			
Hz	V	A	rpm
NY			

**SMR2Q Series Name Plate SP**

The parts list is arranged into the following sections:

Section	Page
9.1 Electric Parts .....	46
9.2 Pendant and Power Supply Parts.....	48
9.3 Side Plates and Suspension Parts .....	50
9.4 Motor Parts .....	52

In the column "Parts Per Trolley" a designator is used for parts that apply only to a particular model or option. Refer to Section 2 for SMR2Q Trolley model numbers and additional descriptions.

# 9.1 Electric Parts

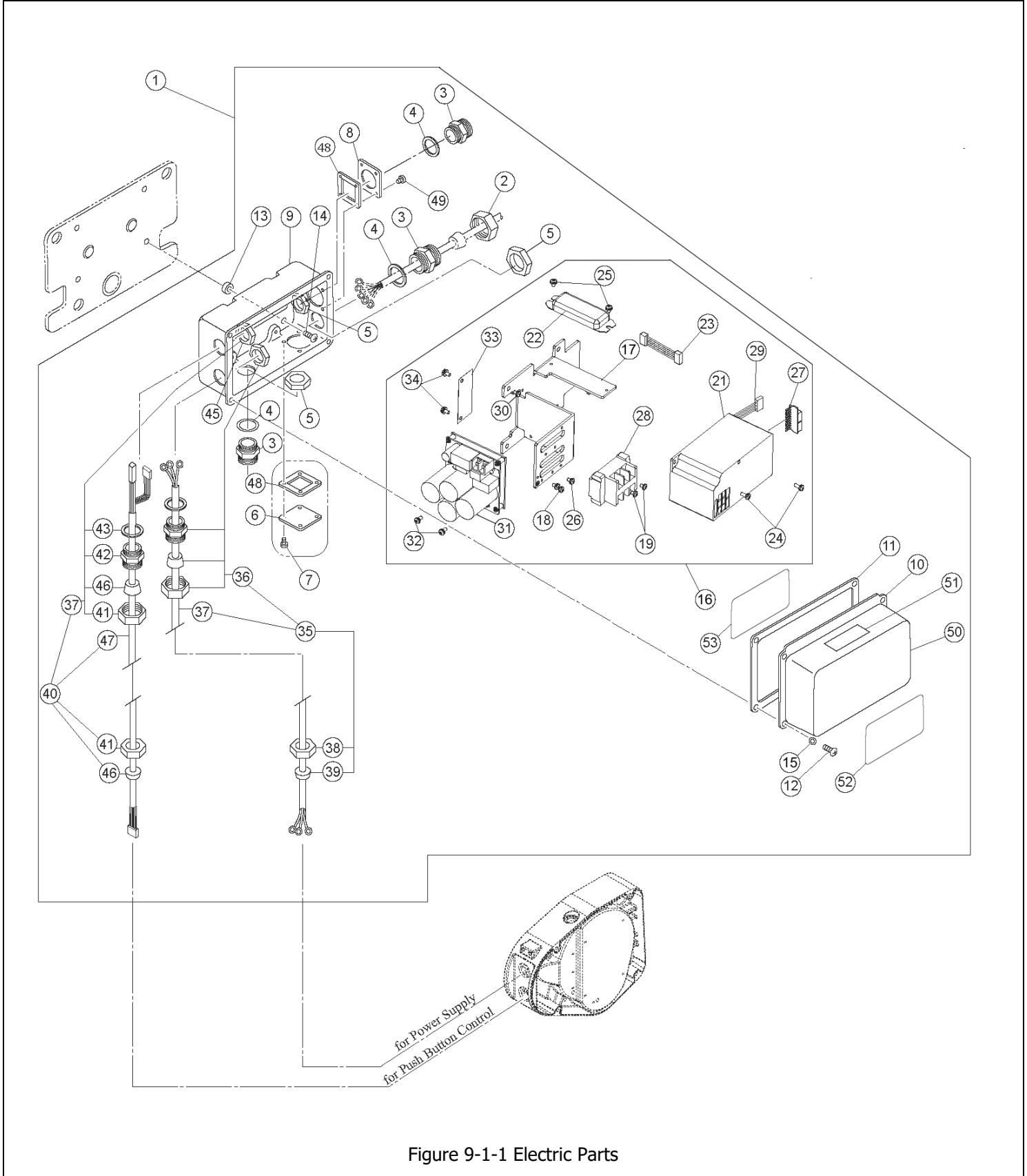

Figure 9-1-1 Electric Parts

## 9.1 Electric Parts

Figure No.	Part Name	Parts Per Trolley	1/8 Ton	1/4 Ton	1/2 Ton	1 Ton
1	Connection Box complete set	1	MR2IVL10R1A1			
2	Holder A	1	ECP5924AA			
3	Holder B	3	ECP5924AB			
4	Packing	3	ECP5924AC			
5	Holder Nut	3	ECP5924AD			
6	Cord Cover	1	E6F630010S			
7	Machine Screw With Spring Washer	4	MS554010			
8	Plate D	1	ECP5924AF			
9	Connection Box	1	MR1DS9401			
10	Connection Box Cover	1	MR1DS9411			
11	Connection Box Packing	1	MR1DS9421			
12	Machine Screw With Spring Washer	4	MS554010			
13	Spacer	4	MS517010			
14	Machine Screw	4	MS551010			
15	Toothed lock washer	4	J1WH012-10050			
16	Complete Plate Assembly	1	MR2IVL10R1A2			
17	Plate	1	MR2DI9437			
18	Machine Screw With Spring Washer	3	MS555010			
19	Machine Screw With Spring Washer	2	J1AW24000808			
21	Inverter assembly	1	INV604E41			
22	Braking resistor	1	INV904E34			
23	Harness	1	EQ1DI9646			
24	Machine Screw With Spring Washer	2	J1AP24001010			
25	Machine Screw With Spring Washer	2	J1AW2-4000808			
26	Machine Screw With Spring Washer	1	J1AP25000808			
27	HBB board	1	ECP91KB22			
28	Terminal 3P	1	ECP1403AA			
29	Inverter lead wire assembly	1	MR2IVL10R9A1			
30	Machine Screw With Spring Washer	4	MS554010			
31	Dual Power Converter (DPC)	1	ECP91KB64			
32	Machine Screw With Spring Washer	1	J1AP24000808			
33	Insulating sheet	1	MR2DI9904			
34	Machine Screw With Spring Washer	1	J1AW2-4000808			
35	Power cable 3C assembly	1	MR2DI2780			
36	Holder assembly	1	ECP5924BD			
37	S.O. Cord 3C	1	12/3			
38	Holder A	1	ECP5924AA			
39	Packing	1	ECP6918AA			
40	Control Cable 5C Assembly	1	MR2DI2770			
41	Holder A	2	ECP5924AA			
42	Holder B	1	ECP5924AB			
43	Packing	1	ECP5924AC			
45	Holder Nut	1	ECP5924AD			
46	Cable packing	2	ECP6910AA			
47	Cable	1	18/5			
48	Cord Cover Packing	2	MS527010			
49	Machine Screw With Spring Washer	4	J1AP24001010			
50	Nameplate SP	1	MR2IVL10R9B71			
51	Warning Seal E (Electric Shock)	1	ER2CS9936			
52	Name Plate B	1	80607	80608	80609	80610
53	Wiring Diagram	1	EWM4DD0F1			

## 9.2 Pendant and Power Supply Parts

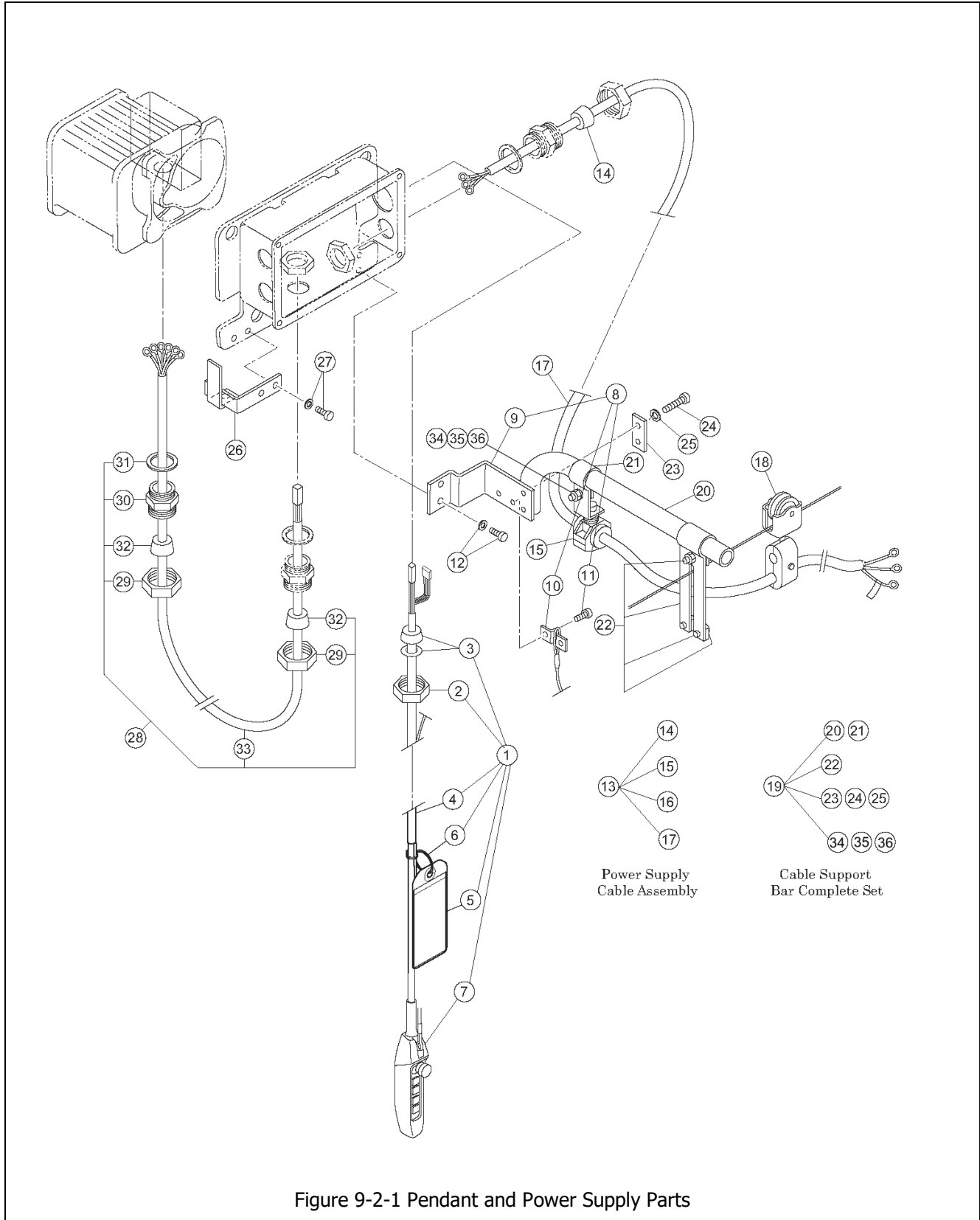

Figure 9-2-1 Pendant and Power Supply Parts



## 9.2 Pendant and Power Supply Parts

Figure No.	Part Name	Parts Per Trolley	1/8 Ton	1/4 Ton	1/2 Ton	1 Ton
1	Push Button Cord 8C Complete Assembly	1	ZLDD02AI2000			
2	Holder A	1	ECP5924AA			
3	Cable packing	1	ECP6916AA			
4	Push button cord 8C	1	18/8P			
5	Warning tag PB	1	SWJ9013AV			
6	Tag holder	1	E3S787003			
7	5 push button switch assembly	1	SWJH220AD			
8	Bar holder assembly	1	MR1DS1481			
9	Bar holder	1	MR1DS9481			
10	Cord chain stopper	1	MR1DS1481			
11	Machine screw with spring washer	2	E6F151003			
12	Socket bolt with spring washer	2	J1BG11002828			
13	Power Supply Cable 3C Assembly	1	ZLZQ11BV1000			
14	Cable Packing	1	ECP6918AA			
15	Cable Support 19 Assembly	1	ECP5900CA			
17	Power Supply Cable 3C	1	12/3			
18	Cable Hanger 15 Assembly	A/R*	MS1733020			
19	Cable Support Bar Assembly	1	MR1DS1491			
20	Cable Support Bar	1	MR1DS9491			
21	Cable Support Arm	1	MR1DS9492			
22	Wire Guide Assembly	1	MR1DS1493			
23	Support Bar Holder (Plate)	1	MR1DS9501			
24	Bolt	2	9093329			
25	Spring Lock Washer	2	9012711			
34	Bolt	1	9093328			
35	Spring Lock Washer	1	9012711			
36	Nut	1	9093424			
26	Cable Hanger Pusher (Beam 75mm)	1	MR1DS9511			
	Cable Hanger Pusher (Beam 100-150mm)	1	MR1DS9512			
27	Socket Bolt With Spring Washer	2	J1BG11002828			
28	Trolley Cable 4C Assembly	1	MR2DI1791			
29	Holder A	2	ECP5924AA			
30	Holder B	1	ECP5924AB			
31	Packing	1	ECP5924AC			
32	Cable Packing	2	ECP6912AA			
33	Trolley Cable 4C	1	16/4			

\*A/R = As Required, one for every 5 ft of power supply cable.

### 9.3 Side Plates and Suspension Parts

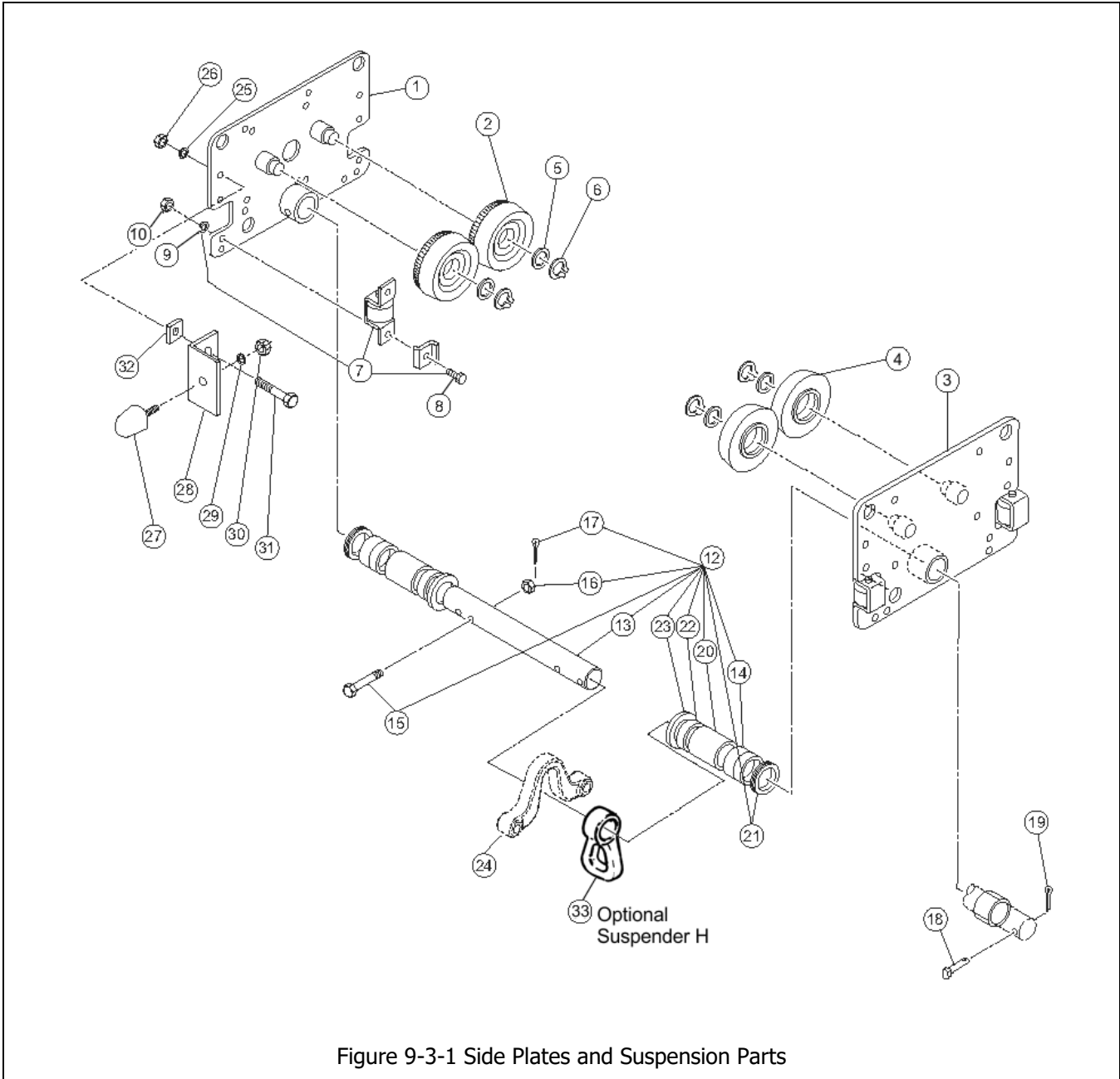

Figure 9-3-1 Side Plates and Suspension Parts

### 9.3 Side Plates and Suspension Parts

Figure No.	Part Name	Parts Per Trolley	1/8 Ton	1/4 Ton	1/2 Ton	1 Ton
1	Side Plate G Assembly	1		MR1DS5201		
2	Track Wheel G Assembly	2		MS1101010		
3	Side Plate S Assembly	1		MR1DS5202		
4	Track Wheel S Assembly	2		MS1102010		
5	Washer	2		MS104010		
6	Snap Ring	2		9047115		
7	Side Roller Assembly	4		MR1DS1211		
8	Bolt	4		9093329		
9	Spring Lock Washer	4		9012711		
10	Nut	4		9093424		
12	Suspension Shaft Assembly	1		MR2DI2135		MR2DI2111
13	Suspension Shaft	1		MSF115010		
14	Thick Spacer (12.5mm)	5		MSF116010		
15	Bolt	1		T3P153020		
16	Slotted Nut	1		T3P154020		
17	Split Pin	1		90094145		
18	Shaft stopper	1		T6G156020		
19	Split pin	1		9009432		
21	Thin Spacer (3.2mm)	8		T6GA020-9117		
		14				T6GA020-9117
22	Thick Spacer L (12.5mm)	2		MR1DS9110		
23	Thin spacer L (5.5mm)	13		MR2DI9113		
24	Suspension Bar			EQ1CI9001		EQ1DI9001
25	Spring Washer	4		9012711		
26	Nut	4		9093424		
27	Bumper	4		MR1DS9631		
28	Bumper Bracket	4		MR1DS9634		
29	Spring Washer	4		9012711		
30	Nut	4		9093424		
31	Bolt	4		9093330		
32	Square Spacer	4		MS006010		
33	Optional Suspender H	1		T6G019020		

#### Extended Suspension Shaft Assemblies

Figure No.	Part Name	Parts Per Trolley	1/8 Ton	1/4 Ton	1/2 Ton	1 Ton
12	Suspension Shaft Assembly	1		MR2DI1136		MR2DI1112
13	Suspension Shaft	1		MSF181010		
14	Thick Spacer (12.5mm)	9		MSF116010		
15	Bolt	1		T3P153020		
16	Slotted Nut	1		T3P154020		
17	Split Pin	1		90094145		
18	Shaft stopper	1		T6G156020		
19	Split pin	1		9009432		
20	Fixing Spacer (50mm)	2		M7SE010S9182		
21	Thin spacer (3.2mm)	8		T6GA020-9117		
		14				T6GA020-9117
22	Thick Spacer L (12.5mm)	2		MR1DS9110		
23	Thin Spacer L (5.5mm)	2		MR2DI9113		

## 9.4 Motor Parts

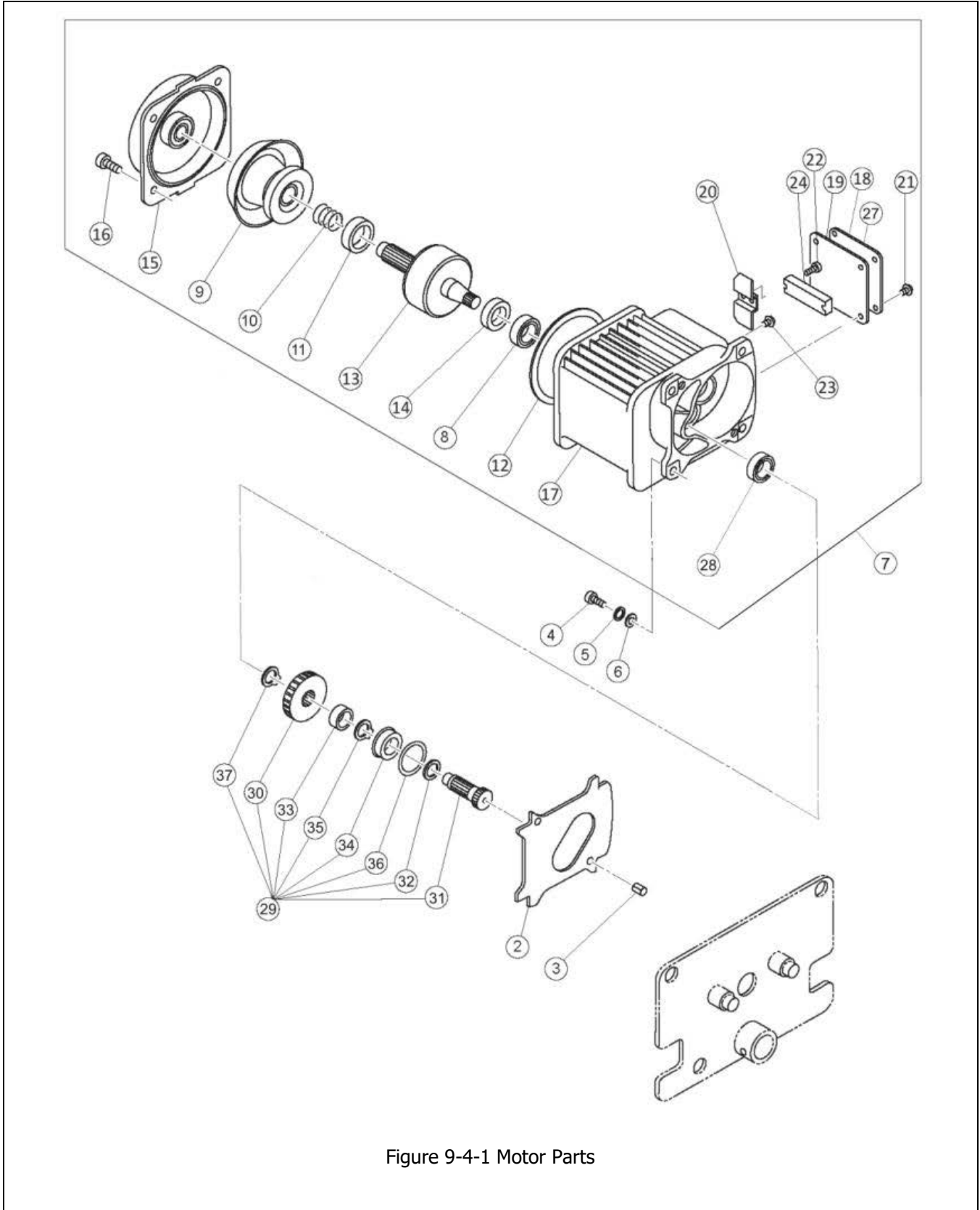

Figure 9-4-1 Motor Parts

9.4 Motor Parts

Figure No.	Part Name	Parts Per Trolley	1/8 Ton	1/4 Ton	1/2 Ton	1 Ton
2	Gear Box Packing	1			MR1DS9248	
3	Set Pin	2			MR1DS9249	
4	Bolt	4			9093328	
5	Spring Lock Washer	4			9012711	
6	Washer	4			9012513	
7	Motor Assembly	1			8348801	
8	Ball Bearing	1			9001004	
9	Brake Drum Assembly	1			MR1DS5261	
10	Brake Spring	1			MS304010	
11	Bumper	1			MR1DS9265	
12	Guard	1			MR1DS9281	
13	Motor Shaft With Rotor	1			MR1DS5291	
14	Oil Seal	1			MR1DS9293	
15	Motor Cover Assembly	1			MR1DS1301	
16	Socket Bolt	4			90912134	
17	Motor Frame With Stator	1			MR1SJE10S5A2	
18	Terminal Cover	1			MR1DS9324	
19	Terminal Cover Packing	1			MR1DS9325	
20	Coil Cover	1			MR1DS9326	
21	Machine Screw With Spring Washer	4			MS554010	
22	Machine Screw With Spring Washer	2			J1AW24002020	
23	Machine Screw With Spring Washer	1			MS555010	
24	Terminal 6P	1			M6FE005S9516	
27	Motor Data Plate	1			IMNBH04VT	
28	Ball Bearing	1			9000502	
29	Gear Assembly	1			MR1DS1241	
30	Gear #2	1			MR1DS9241	
31	Gear #3	1			MR1DS9242	
32	O Ring	1			9013316	
33	Spacer	1			MR1DS9244	
34	Ball Bearing	1			9001211	
35	Snap Ring	2			9047120	
36	O Ring	1			MR1DS9254	
37	Snap Ring	1			9047120	

**This Page Intentionally Left Blank**

**This Page Intentionally Left Blank**



Harrington Hoists, Inc.  
401 West End Avenue  
Manheim, PA 17545

[www.harringtonhoists.com](http://www.harringtonhoists.com)

Toll Free: 800-233-3010  
Phone: 717-665-2000  
Fax: 717-665-2861

**SMR2QOM-ENG**